



# Product Information Guide

March 2022

# Welcome

BA's knowledge and passion for kitchens, bedrooms and components enables our customers to keep the promises they make to their clients.

Every product is crafted with pride by our skilled workforce in our UK factories to provide years of enjoyment.

Continuous investment in sustainable manufacturing, design and innovation ensures that our customers can be confident of always staying ahead. Our dedicated, agile teams deliver on every front, every time.

All copyright is reserved. Any person or company reproducing the same in part or whole, without written permission from BA will be liable to prosecution.

BA Kitchen Components Ltd make every reasonable effort to ensure the accuracy of the information contained in this Product Information Guide. However, we reserve the right to change at any time without notice, information contained in this document and make no warranties or representations as to its accuracy.



# Contents

---

About BA	2-3
Our Team	4-7
MyBA Online System	8
Ordering - Process & Payment	9
Service - Despatch & Delivery	10-11

## Kitchens & Bedrooms

Flat-Pack Kitchens	14-15
True Handleless Flat-Pack Kitchens	16-17
Flat-Pack Bedrooms	18-19
Rigid Kitchens	20-25
True Handleless Rigid Kitchens	26-31

## Stocked Doors and Matching Accessories

Range Overview	34-35
Jayline Range	36-39
Firbeck Range	40-43
Wilton Range	44-47
Lacarre Range	48-51
Thornbury Range	52-55
Hadley Range	56-59

## Made to Measure Doors and Matching Accessories

Range Overview	62-63
Valore Range	64-69
Bella Range	70-91
Jayline Range	92-95
Firbeck Range	96-99
Wilton Range	100-103
Zurfiz Range	104-111

Cabinet Range (ClicBox)	112-119
Cabinet Blind Corner Units	120-121
Tallstor	122-125

Hettich Hinges & Drawers	126-128
SIGE Kitchen Storage	129-131

Handles	132-139
---------	---------

Marketing Support	140-141
Promotional Material	142-143
Book a Tour	144
Door Care	145
Help & Support	146
Conditions of Sale	147-149

---

# About BA

ByBA.co.uk



Established in 1990 and operating from three state of the art factories; one in Cookstown in Co. Tyrone and two in Yorkshire at Rotherham and Doncaster, we are one of the largest producers in Europe supplying small, medium and large manufacturers with bespoke, made-to-measure kitchens, doors, contract volume orders and the largest ranges of matching accessories available in the market today.

BA is a market leader, and we use feedback from our customers to help in our decisions on new products and colours. Regular investment in leading edge software has resulted in a fully linked system from order entry through to production planning, production processing and despatch with the order system updated at every stage of production enabling us to communicate accurate order status information on request.

Order Acknowledgements are automatically emailed to each customer containing full details, prices and estimated despatch dates. Information on your order is available either by contacting our Customer Services Team or can be accessed directly on the website using MyBA (See Page 8 registered customers only).

Over the years the accomplishments made by BA have been recognised and we have been awarded many national and local business awards, for design, service, supply and product quality. By utilising leading edge technology and developing innovative processes, practises and

procedures in all aspects of our business, we are recognized as a market leader in the KBB sector in the UK.

## Quality

All of our production and storage areas are heated using eco friendly systems fuelled using the company's wood waste and this combined with good humidity control ensures consistency in the quality of our raw materials brought into production. This is key to efficiency in production and therefore the quality of the end products and we regularly test and monitor the quality and reliability of both current and new products and materials.

Our dedicated Quality Control Department monitor closely the production procedures and carry out regular checks to evaluate quality at all points of the production process. Using our own ovens and test equipment we can test internally to FIRA regulations ensuring the best quality products at all times.



The mark of responsible forestry

Look for FSC® certified products.  
License code FSC-C013906



Look for PEFC certified products.



Cert No. PC0051

# UK

**OVER 30 YEARS  
MANUFACTURING  
IN THE UK**

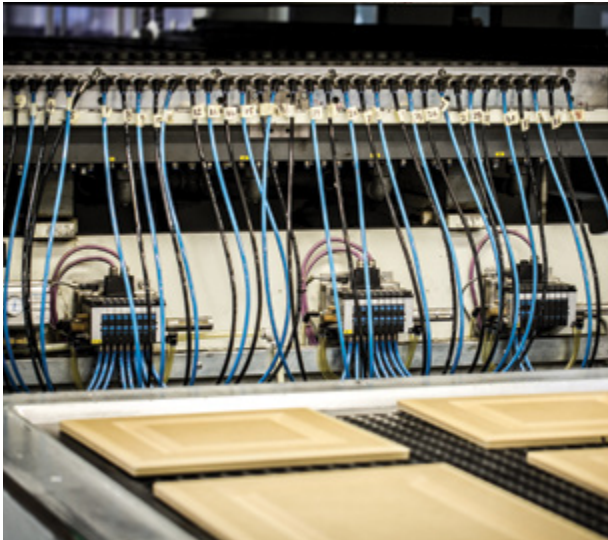

## Process

From our purpose built facilities the use of the very latest in manufacturing machinery and technologies allows us to produce consistently high quality products.

Manufacturing processes designed and developed over many years based on experience within the market and on our own concept designs are the bedrock of our production expertise.

A total of 16 CNC routers including the largest automated board store and router complex in Europe, create the designs on colour matched board and advanced internal software uses an optimising system to plan production efficiently based on colour batches.

The company's software calculates lay-up for the pressing process and this information is sent directly to screens for the press controllers, adding to the end product quality and with added benefits over more traditional operator manual input.

Advanced in-line cleaning machinery at pre-gluing and post pressing stages maintain a consistent high level of

product at all stages of processing prior to final inspection, drilling and packing.

The production process for our acrylic doors uses the latest CNC edge banding lines which have been specifically designed to edge high gloss and acrylic materials. The PUR (Poly Urethane Reactive) gluing system applies a high heat & water resistant glue line. The high precision trimming, polishing & buffing units leave a perfect edge time after time.

Our pressed doors and accessories are produced on a total of 5 pressing lines in our Cookstown and Doncaster Factories; 3 of which are fully automated robotic gluing, pressing and trimming lines, which are the most advanced of their kind in the world.

5 piece doors are created on our own moulding and wrapping lines in Doncaster where experience goes back many years, and again the use of the latest equipment and materials in production and assembly means these are among the best 5 piece doors available today.

After investing £2M in the UK's only fully automated process line to manufacture a 'J' profile handleless door for both standard and M2M sizes, we are investing a further £1M in this product.

With all our door ranges and accessories, final inspection is a crucial part of the process to ensure that all products leave our factories in first class condition.

Packing for despatch is important and every effort is made to ensure that customers receive their goods in the same condition as they leave the factory. Sturdy cardboard boxes produced on our own box making machinery is used along with side and corner protection. We deliver daily throughout the UK and Ireland.

We continue to invest in our facilities with the introduction of the latest Panotec Machine for our packing and despatch lines in Cookstown. The new machine, with its improved software and components, will improve efficiency and speed by 20%.

A new automated packing line has also been delivered and installed at Rotherham.



### BA Cookstown & BA Doncaster

Monday - Thursday:  
8.00am - 5.15pm  
Friday: 8.00am - 3.30pm

### BA Rotherham

Monday - Thursday:  
8.00am - 5.00pm  
Friday: 8.00am - 2.00pm

# Our Team

## Here to Help

---

### Customer Services Team

0330 555 5200

Customer Services

Orders: [cookorders@byba.co.uk](mailto:cookorders@byba.co.uk) • [donorders@byba.co.uk](mailto:donorders@byba.co.uk)

Stock orders: [stockorders@byba.co.uk](mailto:stockorders@byba.co.uk)

Blossom Avenue Aftersales: [aftersales@blossomavenue.co.uk](mailto:aftersales@blossomavenue.co.uk)

0330 555 5600

Blossom Avenue  
Customer Services



**Una Nelson**

[unanelson@byba.co.uk](mailto:unanelson@byba.co.uk)



**Debbie Brown**

[debbiebrown@byba.co.uk](mailto:debbiebrown@byba.co.uk)



**Sheila Martin**

[sheilamartin@byba.co.uk](mailto:sheilamartin@byba.co.uk)



**Avril Hill**

[avrilhill@byba.co.uk](mailto:avrilhill@byba.co.uk)



**Victoria Henry**

[victoriahenry@byba.co.uk](mailto:victoriahenry@byba.co.uk)



**Rhonda Darragh** (After Sales)

[rhondadarragh@byba.co.uk](mailto:rhondadarragh@byba.co.uk)

---

## Marketing Team



**Nuala Brady**  
Group Marketing Manager

[nualabradyl@byba.co.uk](mailto:nualabradyl@byba.co.uk)



**Celine McCreesh**  
Marketing Executive

[celinemcCreesh@byba.co.uk](mailto:celinemcCreesh@byba.co.uk)



**Martina Duggan**  
Marketing Executive

[martinaduggan@byba.co.uk](mailto:martinaduggan@byba.co.uk)



**Aine McKernan**  
Blossom Avenue Brand Manager

[ainemckernan@byba.co.uk](mailto:ainemckernan@byba.co.uk)

---

## Accounts Team | 0330 555 9955



**Helen Lomas**

[helenlomas@byba.co.uk](mailto:helenlomas@byba.co.uk)



**Sarah Bowley**

[sarahbowley@byba.co.uk](mailto:sarahbowley@byba.co.uk)



**Selina Hession**

[selinahession@byba.co.uk](mailto:selinahession@byba.co.uk)



**Rachael Owens**

[rachaelowens@byba.co.uk](mailto:rachaelowens@byba.co.uk)

---

## National Sales Managers



**Anthony McCabe**  
Head of Retail & Industrial Sales

T. 079 1204 4324  
anthonymccabe@byba.co.uk



**Garry Skinner**  
Head of New Build Contracts

T. 077 2563 0970  
garryskinner@byba.co.uk



**Anthony McMorow**  
Head of Trade & National Sales

T. 078 4337 1358  
anthonymcmorow@byba.co.uk

## Regional Sales Managers



**Mani Bhambra**  
North

T. 077 1474 0639  
manibhambra@byba.co.uk



**Gareth Carlyon**  
South

T. 075 4593 0101  
garethcarlyon@byba.co.uk



**Colin McPherson**  
Ireland

T. (048) 077 1567 3258  
colinmcperson@byba.co.uk

---

## Area Sales Managers



**Geraldine Thomson**

T. 078 4908 8798  
geraldinthomson@byba.co.uk



**Mani Bhambra**

T. 077 1474 0639  
manibhambra@byba.co.uk



**Olivia Parelai**

T. 079 3695 5318  
oliviaparelai@byba.co.uk



**Dean Maynard**

T. 079 3695 5240  
deanmaynard@byba.co.uk



**Jon Allaker**

T. 078 7485 5958  
jonallaker@byba.co.uk



**Gareth Carlyon**

T. 075 4593 0101  
garethcarlyon@byba.co.uk



**Jonathan Head**

T. 078 7485 5956  
jonathanhead@byba.co.uk



**Simon Brooks**

T. 075 1599 1631  
simonbrooks@byba.co.uk



**Danny King**

T. 077 1474 0634  
dannyking@byba.co.uk



**Greg Laszlo**

T. 079 3695 5314  
greglaszlo@byba.co.uk



**Gerrad Woods**

T. (048) 077 1474 0635  
gerradwoods@byba.co.uk





# Sales Team

## AREAS COVERED



**Geraldine Thomson**  
T. 078 4908 8798  
geraldinethomson@byba.co.uk



**Mani Bhambra**  
T. 077 1474 0639  
manibhambra@byba.co.uk



**Olivia Parelai**  
T. 079 3695 5318  
oliviaparelai@byba.co.uk



**Dean Maynard**  
T. 079 3695 5240  
deanmaynard@byba.co.uk



**Jon Allaker**  
T. 078 7485 5958  
jonallaker@byba.co.uk



**Gareth Carlyon**  
T. 075 4593 0101  
garethcarlyon@byba.co.uk



**Jonathan Head**  
T. 078 7485 5956  
jonathanhead@byba.co.uk



**Simon Brooks**  
T. 075 1599 1631  
simonbrooks@byba.co.uk



**Danny King**  
T. 077 1474 0634  
dannyking@byba.co.uk



**Greg Laszlo**  
T. 079 3695 5314  
greglaszlo@byba.co.uk



**Colin McPherson**  
T. (048) 077 1567 3258  
colinmcpherson@byba.co.uk



**Gerrad Woods**  
T. (048) 077 1474 0635  
gerradwoods@byba.co.uk

# MyBA

## Interactive Online Service

MyBA is our interactive online service which has been specifically developed to enable you to place and track orders within our production system, in addition to monitoring and making payments to your account when convenient for you.

MyBA has been significantly enhanced to make it easier to order Rigid or Flat-pack Kitchens and Bedrooms.

It's simple, speedy and secure to use – it's been designed by us for you based on your feedback to produce something you can happily call: MyBA.



## Register

Prior to registration you must have an account opened and a valid email address. If registering more than one user we advise using a general email address rather than numerous individual email addresses.

Registration is quick and efficient and you can be registered and enjoying the unique benefits of the system in minutes.

Register today and start enjoying the benefits immediately.

1. Have your BA account number to hand
2. Log on to the website: [byba.co.uk](http://byba.co.uk)
3. Click on the MyBA login button (top right)
4. Follow the simple registration process as instructed

## Benefits



Easy & straightforward to use 24 hours a day, 7 days a week.



Eliminates errors from handwritten orders.



Automatic personalised order management facility.



Quotation folder to store or amend orders until ready for submission.



Easy to use Sloping Door Calculator Wizard.



Live account details; balance, credit limit and available credit.



Easy to use Sloping Door Calculator Wizard.



Live order tracking direct from our production system and after despatch with direct links to the carriers.



Manage and submit replacement/remedial orders online to save time.



Dedicated Marketing Support Section. See page 140.



Be first to know about latest developments with access to the live notice board with news on lead times, promotions, general information, new products and much more.

Multiple Logins available on request.

In line with our continuing desire for development and progress, and to ensure better service and ease of ordering for our customers we have made our product library and pricing available to some of the industry's leading CAD and pricing software specialists. **Contact your provider for details.**



# Ordering Process & Payment

---

## Ordering

Please use one of the following options when placing an order:

- By using MyBA online system –  
(Lead time reduced by 1 day) see page 8.
- By email see page 4.

For speedy and efficient processing of your order please ensure you:

- Include your account number, name and telephone number.
- Include a Purchase Order Number or Name.

When placing an order where there are 2 or more colours / styles / ranges then each will be treated as a separate order when received into BA's system. Each will have a separate delivery charge and potentially a different despatch date.

From 1st February, 2022, when ordering a rigid or flatpack kitchen or bedroom please note you will receive One order acknowledgement with One despatch date.

---

## Payment Terms

### Monthly Account

Goods will be despatched when ready.  
Payment terms are 30 days end of month.

### Pro Forma Account

Orders received via MyBA will require online payment. For orders received by email, please contact the office to make payment upon receipt of your proforma invoice. Once payment has been received we can place your order into the production schedule.

We do not accept payment by cheque for pro-forma accounts.

To apply for an account download a customer registration form from MyBA. Approved applications will be advised of the credit limit (Credit limits include current outstanding balance plus the value of all orders in the BA system), if credit limits are exceeded further orders cannot be processed until the excess amount has been paid.

For accounts queries see contacts on page 4.

We accept all Major Credit & Debit Cards.  
No surcharges apply.



### Details for Bank Payments:

AIB  
Sort Code - 93-82-89  
Account No - 14456099

---

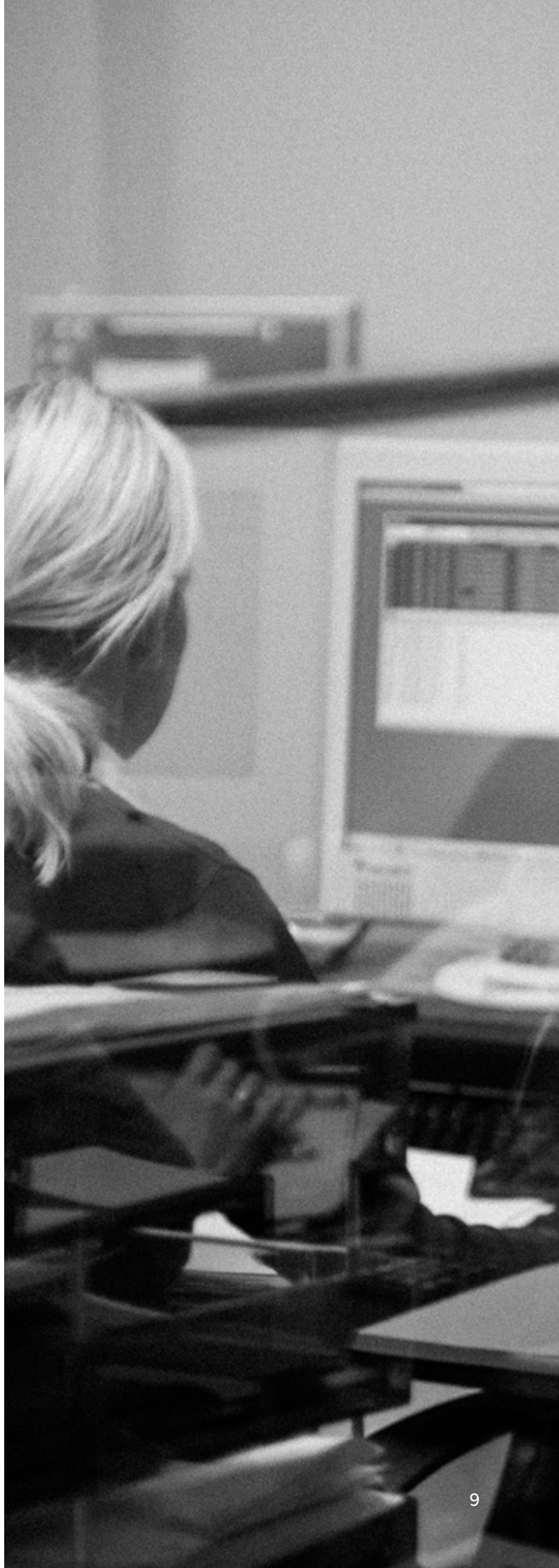

# Service

Despatch & Delivery



## Despatch and Delivery Lead Times\*

Product Description	Working Days Until Despatch*	Delivery Lead Times to					
		UK Mainland	Isle of Wight / C.I. / IoM	Scotland	Highlands & Islands	Northern Ireland	RoI
Flat-Pack Cabinet Range (ClicBox) standard sizes only	1	1	5	2	7	5	5
Flat-Pack Kitchens (inc True Handleless Flat-Pack), standard size cabinets, predrilled doors, hinges and drawers:							
• Supplied with Stocked** doors	1	1	5	2	7	5	5
• Supplied with Thornbury & Hadley doors	10	1	5	2	7	5	5
• Supplied with Valore, Bella or Zurfiz doors	15	2	5	2	7	5	5
Flat-Pack Bedrooms, standard size cabinets, predrilled doors, hinges and drawers (Valore, Bella or Zurfiz doors)	15	2	5	2	7	5	5
Rigid Kitchen (inc True Handleless) supplied with Stocked** doors (excluding Thornbury & Hadley)	15	2-4	5-7	2-4	7-9	5-7	5-7
Rigid Kitchen Supplied with Stocked** doors (excluding Thornbury & Hadley) <i>Premium Delivery</i>	15	3-5	6-8	3-5	8-10	n/a	n/a
Rigid Kitchen Supplied with all other doors.	20	2-4	5-7	2-4	7-9	5-7	5-7
Rigid Kitchen Supplied with all other doors. <i>Premium Delivery.</i>	20	3-5	6-8	3-5	8-10	n/a	n/a
Stocked** door range, standard sizes	1	1	5	2	7	5	5
Stocked Thornbury & Hadley	10	1	5	2	7	5	5
M2M sizes Jayline, Firbeck, Wilton	7	1	5	2	7	5	5
Standard & M2M sizes Valore, Bella, Zurfiz	7	2	5	2	7	1	2
Fastrack Service for M2M Valore, Bella, Zurfiz doors (max. 4 doors)	4	2	5	2	7	1	2
Fastrack Service for Stocked doors** (max 4 doors, 2pm cut-off)	Same day	1	5	2	7	5	5
Ex stock items: Hettich hinges and drawers, handles, cornice, pelmet, etc.	2	2	5	2	7	2	2

## Delivery Service

### Standard Delivery

- 1 person standard delivery to kerbside.
- Customer receives pre-alert of delivery date.
- Delivery to business or home address.

### Premium Delivery

- 2 person over the threshold to ground floor room of choice.
- Customer receives pre-alert of delivery date.
- Delivery to business or home address.
- Removal and recycling of packaging is standard.

### Stocked Fastrack

- 1 person standard delivery to kerbside.
- Customer receives pre-alert of delivery date.
- Delivery to business or home address.
- Max size 1245mm x 650mm.

### Fastrack

- 1 person standard delivery to kerbside.
- Customer receives pre-alert of delivery date.
- Delivery to business or home address.

\* Please check MyBA for live updates on lead times as they may fluctuate slightly during busy periods.

\*\* Jayline, Firbeck, Wilton & Lacarre.

# Kitchens & Bedrooms





# Kitchens & Bedrooms

With over 30 years experience in the manufacture of kitchen and bedroom components, it was only a matter of time before BA expanded to the manufacture of full kitchens & bedrooms.

From flat-pack to rigid assembly options BA offers an extensive range of colours, styles and finishes on fast lead times.



# Flat-Pack Kitchens





# Flat-Pack Kitchens

BA's Flat-Pack Kitchen offering gives you more choice and more control than ever before.

With a Flat-Pack Kitchen order your pre-drilled doors and drawer fronts, cabinets, Hettich soft close drawers & hinges are ready for tool-less assembly.

- Jayline, Firbeck, Wilton & Lacarre doors available on a 24hr despatch. Thornbury/Hadley available on a 10 day despatch. Valore, Bella and Zurfiz doors available on a 15 day despatch.
- Our cabinets are manufactured using the patented ClicBox Uniclic for furniture technology and have been awarded the Heavy Domestic/ Contract Kitchen Furniture FIRA Gold Level H certification. The cabinets are constructed from 18mm MFC and fully glued for maximum strength.
- Clic Cabinets in 5 colours ready for tool-less assembly.
- Pre-assembled drawers including ALL fittings.
- Pre-drilled doors & drawer fronts.
- Matching handles and accessories.

**Valore Jayline Firbeck Wilton Bella  
Zurfiz Lacarre Thornbury Hadley**



Order your Flat-Pack kitchen  
on MyBA in JUST 4 easy steps

**1** Choose your  
Door range

**2** Choose your  
cabinet colour,  
hinges & drawers

**3** Choose your  
cabinet options

**4** Choose your  
accessory and  
handle options

# True Handleless Flat-Pack Kitchens

InRail



# True Handleless Flat-Pack Kitchens InRail

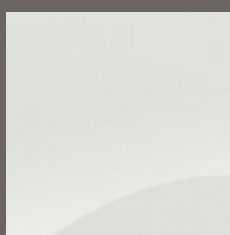

**Firbeck**

Supergloss White

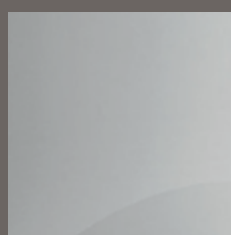

**Firbeck**

Supergloss Light Grey



**Gola**

Brushed Aluminium

- Stocked product – 24 hours until despatch.
- White cabinet only.
- 2 slab colours available – Supergloss White and Supergloss Light Grey (Firbeck).
- Brushed Aluminium Rail.
- Hettich silver drawers & hinges.
- Tower units have single vertical metal rail.



Order your InRail Flat-Pack  
Kitchen on MyBA

# Flat-Pack Bedrooms



# Flat-Pack Bedrooms

Flat-Pack Bedrooms by BA is an exclusive range of bedroom furniture made simple. A collection inspired by personal choice designed for today's bedroom lifestyle.

With stylish door design and intelligent "Clic" assembly technology our bedroom range will offer you the flexibility to tailor the look you want. With 3 cabinet colours on offer, choose from a large selection of on-trend frontal colours, 3 door mechanisms (hinged, sliding or bi-fold) and bespoke internals to optimise bedroom space with clever design.

From contemporary to traditional styles installation has never been simpler.

**Valore Bella Zurfiz**



Order your Flat-Pack bedroom on MyBA in JUST 6 easy steps

- 1** Choose Your Door Mechanism  
(hinged, sliding or bi-fold)
- 2** Choose Your Door Range
- 3** Choose your cabinet colour & hinges
- 4** Choose your cabinet options
- 5** Choose your chests
- 6** Choose your Clad-on-kits/ Accessories/ Handles

# Rigid Kitchens



# Rigid Kitchens

Our made to measure rigid kitchen offering provides the best solution to hassle free, pre-assembled rigid cabinets with over 110 stylish door frontals, drawers, storage solutions, handles and matching accessories to choose from.

- A full rigid made to measure UK manufactured kitchen.
- A rigid kitchen supplied with Jayline, Firbeck, Wilton and Lacarre standard size doors is 15 working days until despatch. A rigid kitchen supplied with all other doors is 20 days until despatch.
- Our cabinets are manufactured using the patented ClicBox Uniclic for furniture technology and have been awarded the Heavy Domestic/ Contract Kitchen Furniture FIRA Gold Level H certification. The cabinets are constructed from 18mm MFC and fully glued for maximum strength.
- 5 on-trend cabinet colours.
- Online easy ordering and full tracking through to delivery on our MyBA ordering portal.
- Two person white glove delivery option from B2B, B2C, home or to site. Remove and recycle packaging.

**Valore Jayline Firbeck Wilton Bella  
Zurfiz Lacarre Thornbury Hadley**



Order your Rigid Kitchens on MyBA  
in JUST 5 easy steps

**1** Choose your door style & colour

**2** Choose your cabinet type

**3** Choose your cabinet colour, hinges & drawers

**4** Choose your cabinet options

**5** Choose your accessory and handle options

# Rigid Kitchens

Over 100 Rigid Cabinet options.  
M2M cabinets available.

		150w	300w	400w	450w	500w	600w	700w	800w	900w	1000w
H x D	BASE CABINETS										
720h x 570d	Highline	■	■	■	■	■	■	■	■	■	■
720h x 570d	Blind Corner Base										■
720h x 570d	Drawerline Base		■	■	■	■	■		■	■	■
720h x 570d	5 Drawer Pack (5 standard drawers)		■			■	■				
720h x 570d	4 Drawer Pack (3 standard + 1 pan drawer)					■	■				
720h x 570d	3 Drawer Pack (1 standard + 2 pan drawers)					■	■		■	■	■
720h x 570d	4 Drawer Pack (4 standard drawers)			■		■	■				
720h x 570d	3 Drawer Pack (2 standard + 1 pan drawer)					■	■				
720h x 570d	2 Drawer Pack (2 pan drawers)					■	■		■	■	■
720h x 570d	Base Under Oven						■				
720h x 570d	Sink Base						■				
460h x 570d	Belfast Sink						■				
H x D	WALL CABINETS										
575h x 330d	Wall Cabinet (short)		■	■	■	■	■				
720h x 330d	Wall Cabinet (standard)		■	■	■	■	■	■	■	■	■
900h x 330d	Wall Cabinet (tall)		■	■		■	■		■	■	■
720h x 330d	Blind Corner Wall Cabinet (standard)						■				
900h x 330d	Blind Corner Wall Cabinet (tall)						■				
360h x 330d	Bridging					■	■		■	■	■
288h x 330d	Bridging (short)					■	■				
900h x 450d	Boiler Cabinet (no back)						■				
H x D	TALL CABINETS										
1970h x 570d	Larder (standard)		■	■		■	■				
1970h x 570d	Larder with 2 Pan Drawers (standard)					■	■				
1970h x 570d	Larder with Inner Drawers (standard)					■	■				
2150h x 570d	Larder (tall)		■	■		■	■				
2150h x 570d	Larder with 2 Pan Drawers (tall)					■	■				
2150h x 570d	Larder with Inner Drawers (tall)					■	■				
2150h x 570d	Larder with 2 Doors - 1424 + 715mm (tall)		■	■		■	■				
1970h x 570d	Butler's Pantry with 2 Internal Drawers (standard)										■
1970h x 570d	Butler's Pantry with 2 x 355 Drawers (standard)										■
2150h x 570d	Butler's Pantry with 2 Internal Drawers (tall)										■
2150h x 570d	Butler's Pantry with 2 x 355 Drawers (tall)										■



H x D	TALL CABINETS (CONTINUED)	150w	300w	400w	450w	500w	600w	700w	800w	900w	1000w
1970h x 570d	Single Oven (standard)						■				
1970h x 570d	Single Oven with 2 Pan Drawers (standard)						■				
1970h x 570d	Double Oven (standard)						■				
1970h x 570d	Double Oven with 2 Pan Drawers (standard)						■				
1970h x 570d	Single Oven + Compact / Microwave (standard)						■				
1970h x 570d	Single Oven + Compact / Microwave with 1 Pan Drawer + 1 Inner Drawer (standard)						■				
1970h x 570d	Compact / Microwave (standard)						■				
1970h x 570d	Compact / Microwave with 2 Pan Drawers (standard)						■				
2150h x 570d	Single Oven (tall)						■				
2150h x 570d	Single Oven with 2 Pan Drawers (tall)						■				
2150h x 570d	Double Oven (tall)						■				
2150h x 570d	Double Oven with 2 Pan Drawers (tall)						■				
2150h x 570d	Single Oven + Compact / Microwave (tall)						■				
2150h x 570d	Single Oven + Compact / Microwave with 1 Pan Drawer + 1 Inner Drawer (tall)						■				
2150h x 570d	Compact / Microwave (tall)						■				
2150h x 570d	Compact / Microwave with 2 Pan Drawers (tall)						■				
1970h x 570d	70/30 Cooling (standard)						■				
1970h x 570d	50/50 Cooling (standard)						■				
1970h x 570d	Single Cooling (standard)						■				
1970h x 570d	Single Cooling with 2 Pan Drawers (standard)						■				
2150h x 570d	70/30 Cooling (tall)						■				
2150h x 570d	50/50 Cooling (tall)						■				
2150h x 570d	Single Cooling (tall)						■				
2150h x 570d	Single Cooling with 2 Pan Drawers (tall)						■				



## Standard Integrated Cooking

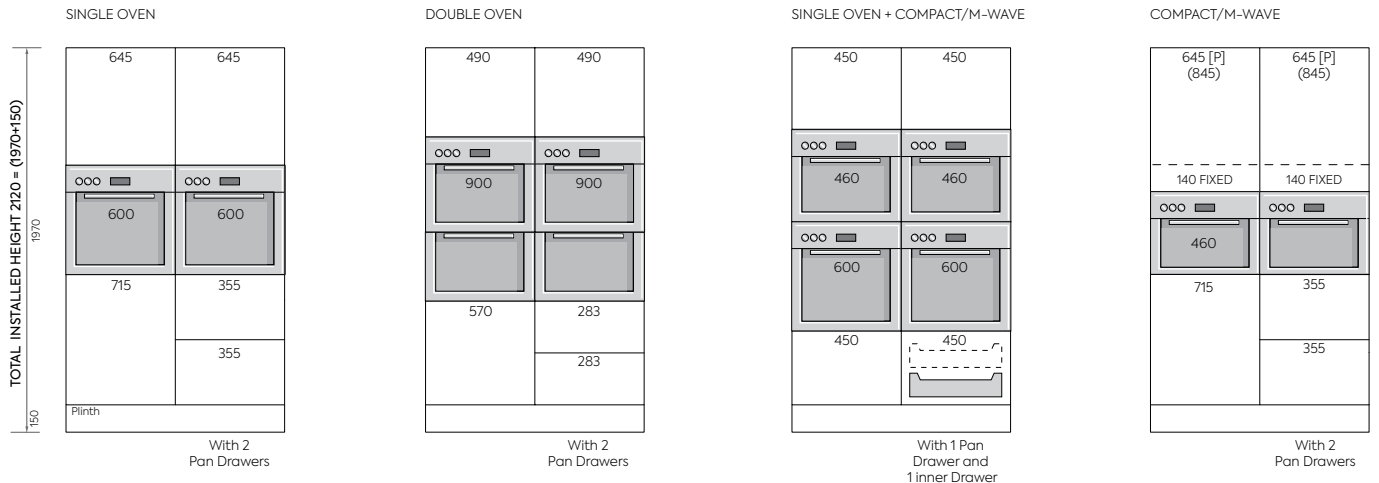

## Tall Integrated Cooking

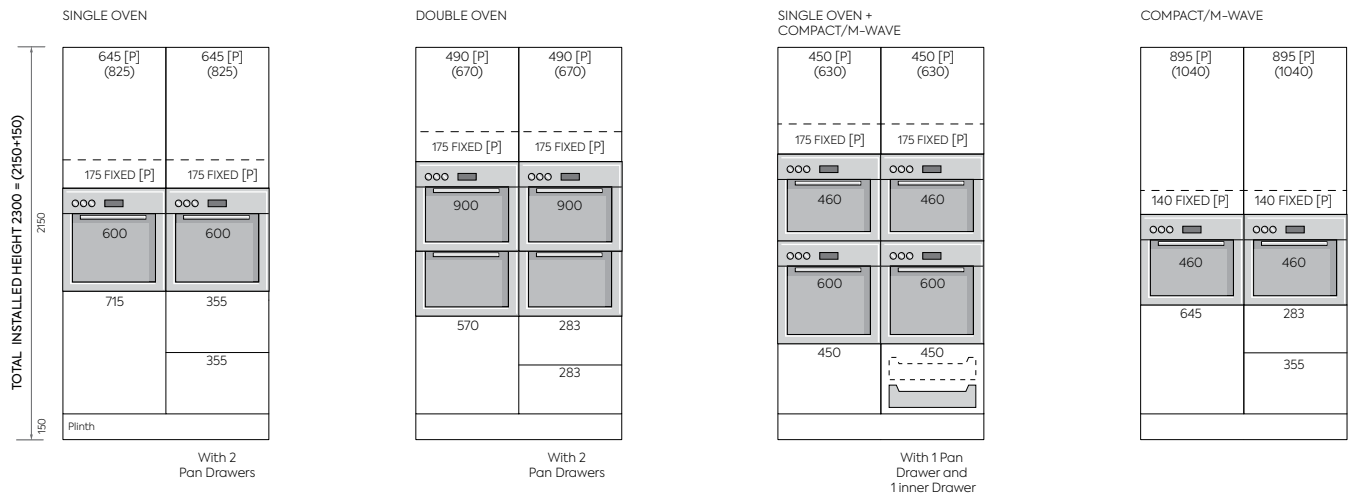

## Standard Integrated Cooling

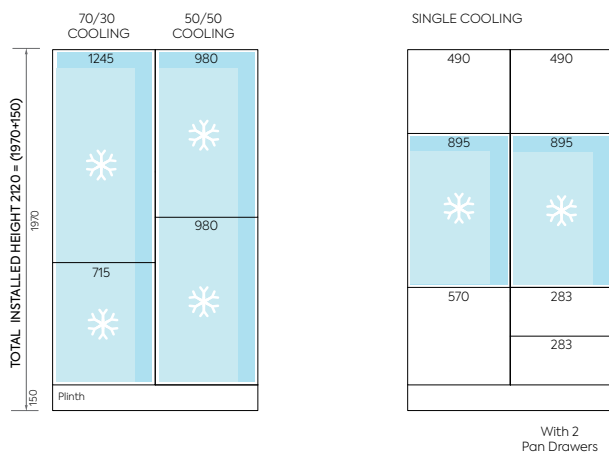

## Tall Integrated Cooling

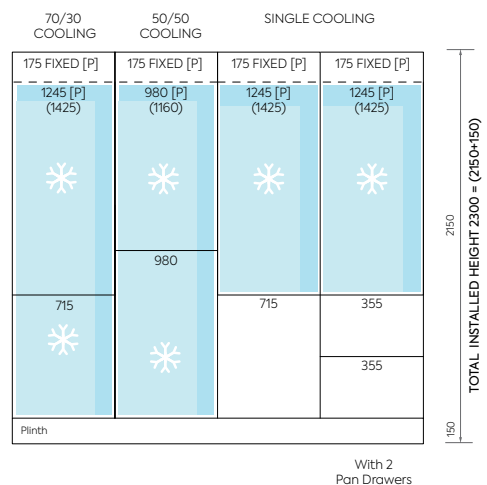

# True Handleless Rigid Kitchens

InRail



# True Handleless Rigid Kitchens

## InRail

Providing that sleek minimalist style couldn't be easier with the new GOLA Handleless Rail system in 5 new rail colours.

- A full rigid made to measure UK manufactured kitchen.
- A rigid kitchen supplied with Firbeck standard size doors is 15 working days until despatch. A rigid kitchen supplied with all other doors is 20 days until despatch.
- Our cabinets are manufactured using the patented ClicBox Uniclic for furniture technology and have been awarded the Heavy Domestic/Contract Kitchen Furniture FIRA Gold Level H certification. The cabinets are constructed from 18mm MFC and fully glued for maximum strength.
- 5 on-trend cabinet colours.
- Online easy ordering and full tracking through to delivery on our MyBA ordering portal.
- Two person white glove delivery option from B2B, B2C, home or to site. Remove and recycle packaging is standard.

**Valore Firbeck Bella Zurfiz**



Brushed  
Aluminium

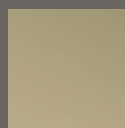

Brushed  
Brass



Brushed  
Copper

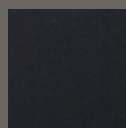

Matt  
Black

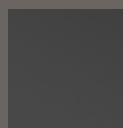

Matt  
Graphite



Order your InRail  
Kitchen on MyBA



## Standard Integrated Cooking

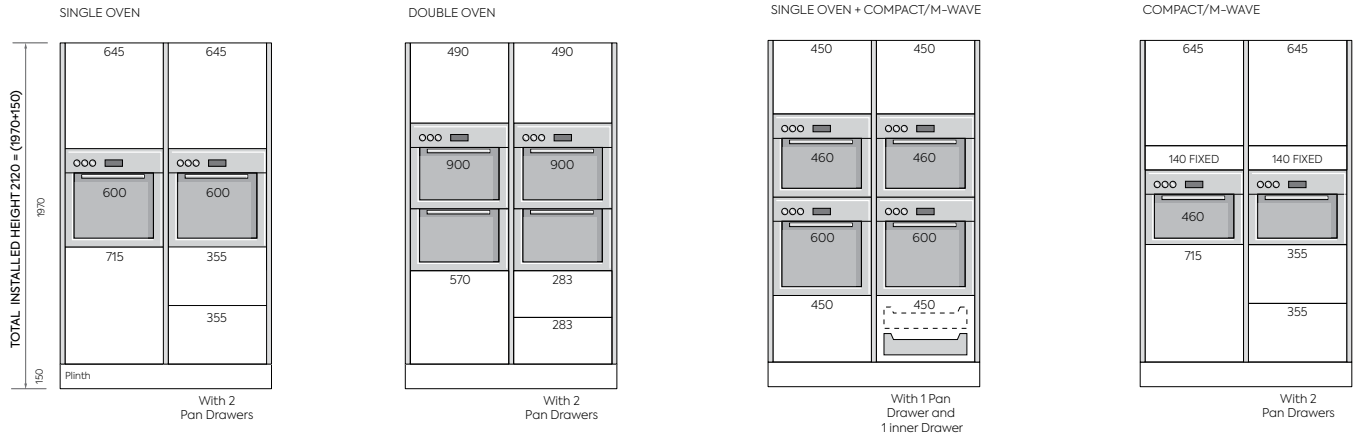

## Tall Integrated Cooking

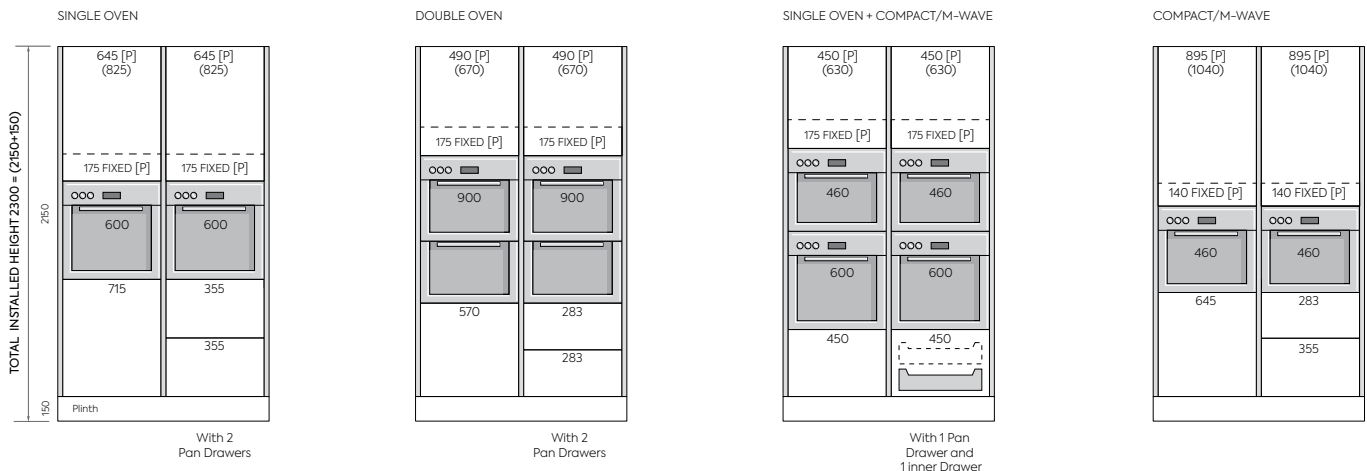

# True Handleless

## InRail Components

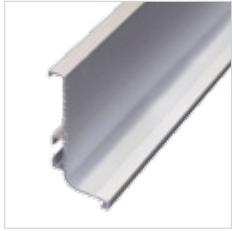

**4.1m Handleless Worktop Rail GOLA B**

Brushed Aluminium  
Code: AHGBAWR  
Brushed Brass  
Code: AHGBBWR  
Brushed Copper  
Code: AHGBCWR  
Matt Black  
Code: AHGMBWR  
Matt Graphite  
Code: AHGMGWR



**Handleless Worktop End Caps (Pair) GOLA B**

Brushed Aluminium  
Code: AHGBAWEC  
Brushed Brass  
Code: AHGBBWEC  
Brushed Copper  
Code: AHGBCWEC  
Matt Black  
Code: AHGMBWEC  
Matt Graphite  
Code: AHGMGWEC



**Handleless Worktop Internal Corner GOLA B**

Brushed Aluminium  
Code: AHGBAWINT  
Brushed Brass  
Code: AHGBBWINT  
Brushed Copper  
Code: AHGBCWINT  
Matt Black  
Code: AHGMBWINT  
Matt Graphite  
Code: AHGMGWINT



**Handleless Worktop External Corner GOLA B**

Brushed Aluminium  
Code: AHGBAWEXT  
Brushed Brass  
Code: AHGBBWEXT  
Brushed Copper  
Code: AHGBCWEXT  
Matt Black  
Code: AHGMBWEXT  
Matt Graphite  
Code: AHGMGWEXT



**4.1m Handleless Drawer Rail GOLA C**

Brushed Aluminium  
Code: AHGBADR  
Brushed Brass  
Code: AHGBBDR  
Brushed Copper  
Code: AHGBCDR  
Matt Black  
Code: AHGMBDR  
Matt Graphite  
Code: AHGMGDR



**Handleless Drawer End Caps (Pair) GOLA C**

Brushed Aluminium  
Code: AHGBADEC  
Brushed Brass  
Code: AHGBBDEC  
Brushed Copper  
Code: AHGBCDEC  
Matt Black  
Code: AHGMBDEC  
Matt Graphite  
Code: AHGMGDEC



**Handleless Drawer Internal Corner GOLA C**

Brushed Aluminium  
Code: AHGBADINT  
Brushed Brass  
Code: AHGBBDINT  
Brushed Copper  
Code: AHGBCDINT  
Matt Black  
Code: AHGMBDINT  
Matt Graphite  
Code: AHGMGDINT



**Handleless Drawer External Corner GOLA C**

Brushed Aluminium  
Code: AHGBADEXT  
Brushed Brass  
Code: AHGBBDEXT  
Brushed Copper  
Code: AHGBCDEXT  
Matt Black  
Code: AHGMBDEXT  
Matt Graphite  
Code: AHGMGDEXT

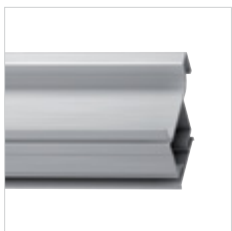

**2.4m Handleless Vertical End Rail GOLA E**

Brushed Aluminium  
Code: AHGBAVER  
Brushed Brass  
Code: AHGBBVER  
Brushed Copper  
Code: AHGBCVER  
Matt Black  
Code: AHGMBVER  
Matt Graphite  
Code: AHGMGVER



**2.4m Handleless Vertical Mid Rail GOLA E**

Brushed Aluminium  
Code: AHGBAVMR  
Brushed Brass  
Code: AHGBBVMR  
Brushed Copper  
Code: AHGBCVMR  
Matt Black  
Code: AHGMBVMR  
Matt Graphite  
Code: AHGMGVMR



**580mm Oven Fitting Profile GOLA E**

Brushed Aluminium  
Code: AHGBAOP  
Brushed Brass  
Code: AHGBBOP  
Brushed Copper  
Code: AHGBCOP  
Matt Black  
Code: AHGMBOP  
Matt Graphite  
Code: AHGMGOP



**Handleless Fixing Clips (Pair)**

Nylon  
Code: AHGFCLIP





# Stocked Doors and Matching Accessories





# Stocked Doors and Matching Accessories

A stunning collection of standard sized kitchen doors and drawer fronts in a choice of 43 finishes.

This collection of elegantly designed kitchen doors and drawer fronts are available in 43 on-trend finishes. Choose from a combination of style and elegance that will instill lasting personality and character by bringing out the very best in any home.

- Choose from 43 door options.
- Available in standard sized doors, drawer fronts and matching accessories.
- Finishes available in painted timber, supermatt, supergloss and woodgrain effect.
- A selection of stocked doors are FSC® certified and a selection have attained the FIRA gold award.
- The Jayline, Firbeck, Wilton, Lacarre, Thornbury and Hadley ranges carry a 6 year warranty.
- Jayline, Firbeck, Wilton and Lacarre In stock and despatched from 24 hours\* Thornbury & Hadley despatched within 10 days\*

\*Please check communication updates on MyBA for live updates on lead times as they may fluctuate slightly during busy periods.

# Stocked Doors\*

## Range Overview



### Jayline Range

p36-39

A 19mm MDF J Profile handleless door, available in a range of 11 stunning supermatt and supergloss colours. Has a full wrap door with a continuous laminate on the top edge and face. All colour options have matching melamine reverse.



### Firbeck Range

p40-43

A 18mm MDF slab door with matching edging in a range of 11 stunning supermatt and supergloss colours. All colour options have matching melamine reverse.



## Wilton Range

p44-47

9 colours are available in this 5-piece door construction. The frames are 120mm W x 22mm MDF. Panels are 6mm. Drawer fronts are 1 piece 22mm. Doors and drawers have a 2mm chamfered edge.

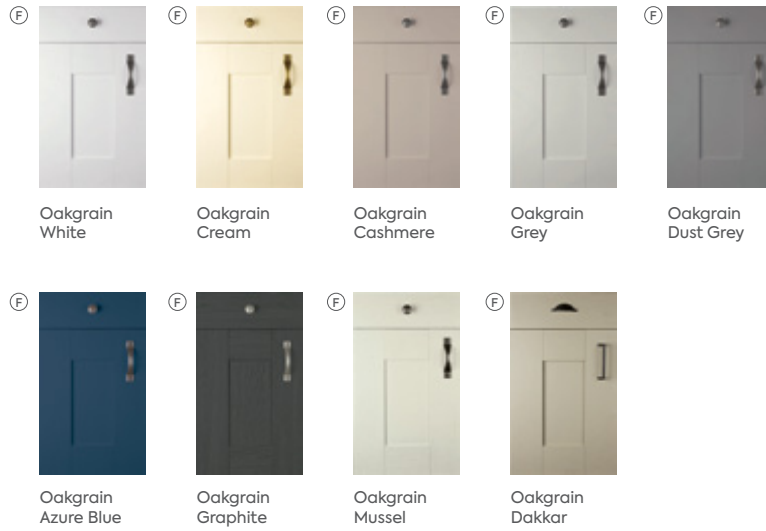

## Lacarre Range

p48-51

A 22mm MDF J Profile handleless door, available in 2 high gloss painted finishes. All colour options have matching melamine reverse.



## Thornbury Range

p52-55

A 20mm 5-piece solid ash timber frame with veneered centre panel and beaded detail. Available in 4 matt painted colours.



## Hadley Range

p56-59

A 20mm 5-piece solid ash timber frame with veneered centre panel. Available in 6 matt painted colours.



Certifications: Colours marked (F) are FSC® certified

\*Please note colour swatches represented in this document are for reference only and final purchasing decisions should only be made after viewing a physical swatch or sample door (see page 143).

# Stocked Doors and Matching Accessories





# Jayline

A stunning 'J' Profile Handleless door in standard sized kitchen doors and drawer fronts in Supermatt and Supergloss colours.

- 19mm MDF 'J' Profile door
- Choose from 11 on-trend colours
- Available in standard sized doors, drawer fronts and matching accessories.
- In stock and despatched from 24 hours\*
- The Jayline range carry a 6 year warranty.



24hr  
despatch



Cert No. PC0051

FIRA Gold Certification is the ultimate mark of product excellence within the furniture industry and provides a solid reassurance that a product meets all necessary standards.

A selection of Jayline doors have been tested by FIRA International and achieved FIRA Gold Certification Tests : **BS 6222-3**.

\*Please check communication updates on MyBA for live updates on lead times as they may fluctuate slightly during busy periods.

# Jayline

## Range Doors



### RANGE SPECIFICATION

19mm MDF J Profile Handleless Door.

Wrapped door with a continuous laminate on top edge and face. Jayline uses a PUR adhesive system giving the highest heat and moisture resistance available.

Note: When ordering Jayline doors with hinge-holes, specify handing and groove (handle) position.

E.g. drill 98T 98B LH handle top.

### CERTIFICATION

Products marked (F) are FSC® certified. The Jayline range has attained the FIRA gold award.

### BOARD MATCHES

Supergloss/Supermatt

The manufacturers board references listed below are for guidance only. Check colour samples from your board supplier for your own approval.

#### WHITE

Egger: <b>W980</b>	Kronospan: <b>K101</b>	Pfleiderer: <b>W300</b>	Finsa White: <b>020</b>
--------------------	------------------------	-------------------------	-------------------------

#### LIGHT GREY

Egger: <b>U708</b>	Kronospan: <b>0112</b>	Finsa: <b>U12 Natural Grey</b>	Pfleiderer: <b>U1188</b>
--------------------	------------------------	--------------------------------	--------------------------

#### DUST GREY

Egger: <b>U732</b>	Pfleiderer: <b>U12150</b>	Kronospan: <b>0171 Slate Grey</b>
--------------------	---------------------------	-----------------------------------

#### GRAPHITE

Egger: <b>U961</b>	Pfleiderer: <b>U17010 (U1980) Terra Brown</b>	Kronospan: <b>0164 Anthracite</b>
--------------------	-----------------------------------------------	-----------------------------------

#### INDIGO BLUE

Egger: <b>U599</b>
--------------------

#### CASHMERE

Egger: <b>U702</b>	Kronospan: <b>5981</b>	Pfleiderer: <b>U1168</b>	Finsa: <b>15R</b>
--------------------	------------------------	--------------------------	-------------------

Made to measure sizes available on a 7 day lead time (see page 92-95).

			
Supergloss White	Supergloss Light Grey	Supergloss Cashmere	Supergloss Dust Grey
			
Supergloss Graphite	Supermatt White	Supermatt Light Grey	Supermatt Cashmere
			
Supermatt Dust Grey	Supermatt Graphite	Supermatt Indigo Blue	

Size H x W	Size H x W
110 x 596 Square Panel	570 x 296
140 x 296	570 x 396
140 x 396	570 x 446
140 x 446	570 x 496
140 x 496	570 x 596
140 x 596	645 x 596
140 x 796	715 x 146
140 x 896	715 x 236
140 x 996	715 x 296
175 x 396	715 x 346
175 x 496	715 x 396
175 x 596	715 x 446
283 x 496	715 x 496
283 x 596	715 x 596
283 x 796	895 x 236
283 x 896	895 x 296
283 x 996	895 x 396
355 x 496	895 x 496
355 x 596	895 x 596
355 x 796	980 x 596
355 x 896	1245 x 296
355 x 996	1245 x 396
450 x 596	1245 x 496
490 x 596	1245 x 596

We offer a drilling service for your convenience. Hinge hole drilling is 35mm x 13mm deep.



# Jayline

## Range Accessories



**Breakfast Bar Panel**  
2100H x 900W (Made to Order)



**Pre Glued Edging Tape**  
22T x 50M (Matt & Gloss Finish Available)



**Multi-Purpose Rail**  
55W x 36T x 3050L

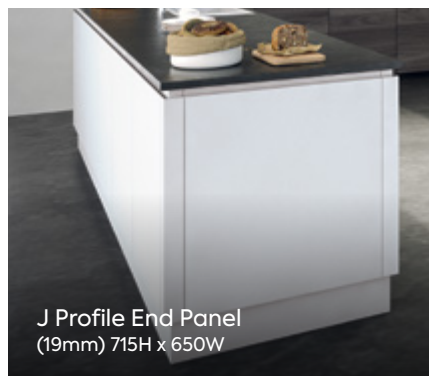

**J Profile End Panel**  
(19mm) 715H x 650W



**Square End Panel (18mm)**  
800H x 350W  
900H x 600W  
2150H x 600W

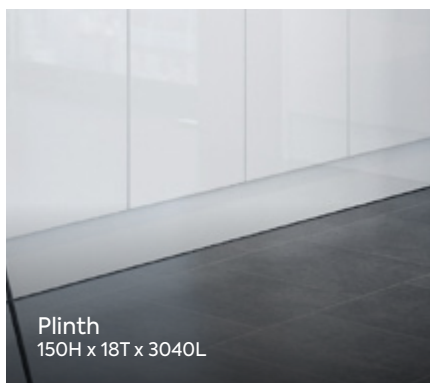

**Plinth**  
150H x 18T x 3040L

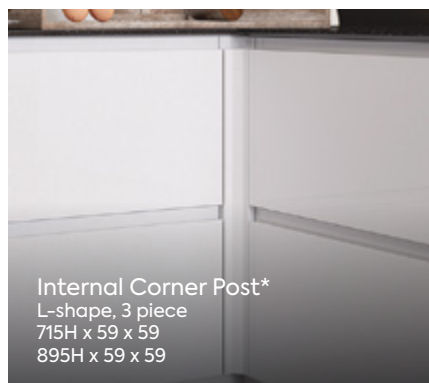

**Internal Corner Post\***  
L-shape, 3 piece  
715H x 59 x 59  
895H x 59 x 59



**External Corner Post**  
715H x 59 x 59

\* See page 120 & 121 for corner planning details.

# Stocked Doors and Matching Accessories





# Firbeck

A stunning collection of standard sized kitchen doors and drawer fronts. This slab door has a matching edge and is a superb choice for modern kitchen styling.

- 18mm MDF slab door
- Choose from 11 on-trend colours
- Available in standard sized doors, drawer fronts and matching accessories.
- The Firbeck range carry a 6 year warranty.



24hr  
despatch



Cert No. PC0051

FIRA Gold Certification is the ultimate mark of product excellence within the furniture industry and provides a solid reassurance that a product meets all necessary standards.

A selection of Firbeck doors have been tested by FIRA International and achieved FIRA Gold Certification Tests : **BS 6222-3**.

\*Please check communication updates on MyBA for live updates on lead times as they may fluctuate slightly during busy periods.

### RANGE SPECIFICATION

18mm MDF slab door with matching edging. Laminated supergloss / supermatt surface with a matching melamine colour reverse. Laminated and edged with a PUR adhesive system giving the highest heat and moisture resistance available.

### CERTIFICATION

Products marked (F) are FSC® certified. The Firbeck range has attained the FIRA gold award

### BOARD MATCHES

Supergloss/Supermatt

The manufacturers board references listed below are for guidance only. Check colour samples from your board supplier for your own approval.

#### WHITE

Egger: **W1000**

#### INDIGO BLUE

Egger: **U599**

#### LIGHT GREY

Egger: **U708**

Kronospan: **0112**

Finsa: **U12 Natural Grey**

Pfleiderer: **U1188**

#### CASHMERE

Egger: **U702**

Kronospan: **5981**

Pfleiderer: **U1168**

Finsa: **15R**

#### DUST GREY

Egger: **U732**

Pfleiderer: **U12150**

Kronospan: **0171 Slate Grey**

Finsa: **Gris Tormenta 09F**

#### GRAPHITE

Egger: **U961**

Pfleiderer: **U17010 (U1980) Terra Brown**

Kronospan: **0164 Anthracite**

Made to measure sizes available on a 7 day lead time (see page 96-99).

			
Supergloss White	Supergloss Light Grey	Supergloss Cashmere	Supergloss Dust Grey
			
Supergloss Graphite	Supermatt White	Supermatt Light Grey	Supermatt Cashmere
			
Supermatt Dust Grey	Supermatt Graphite	Supermatt Indigo Blue	

#### Size H x W

110 x 596

140 x 296

140 x 396

140 x 446

140 x 496

140 x 596

140 x 796

140 x 896

140 x 996

175 x 396

175 x 496

175 x 596

283 x 496

283 x 596

283 x 796

283 x 896

283 x 996

355 x 496

355 x 596

355 x 796

355 x 896

355 x 996

450 x 596

490 x 596

#### Size H x W

570 x 296

570 x 396

570 x 446

570 x 496

570 x 596

645 x 596

715 x 146

715 x 296

715 x 346

715 x 396

715 x 446

715 x 496

715 x 596

895 x 296

895 x 396

895 x 496

895 x 596

980 x 596

1245 x 296

1245 x 396

1245 x 496

1245 x 596

# Firbeck

## Range Accessories

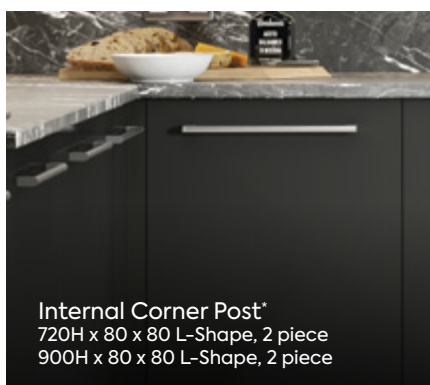

Pre Glued Edging Tape  
22T x 50M (Matt & Gloss Finish Available)

\* See page 120 & 121 for corner planning details.

# Stocked Doors and Matching Accessories





# Wilton

A stunning 5 piece door available in standard sized kitchen doors and drawer fronts.

- 22mm 5 piece door construction
- Choose from 9 oakgrain colours
- Available in standard sized doors, drawer fronts and matching accessories.
- In stock and despatched from 24 hours\*
- The Wilton range carry a 6 year warranty.



24hr  
despatch



Cert No. PC0051

FIRA Gold Certification is the ultimate mark of product excellence within the furniture industry and provides a solid reassurance that a product meets all necessary standards.

A selection of Wilton doors have been tested by FIRA International and achieved FIRA Gold Certification Tests : **BS 6222-3**.

\*Please check communication updates on MyBA for live updates on lead times as they may fluctuate slightly during busy periods.

### RANGE SPECIFICATION

5 piece door construction.  
The frames are 120mm W x 22mm MDF. Panels are 6mm. Drawer fronts are 1 piece 22mm. Doors and drawer have a 2mm chamfered edge. 110, 140, 175 drawer fronts and 715 x 146 door are 1 piece. All other sizes are 5 piece. 110, 140 and 175 drawer fronts have horizontal grain.

### CERTIFICATION

Products marked (F) are FSC® certified.  
Products marked (P) are PEFC certified.  
The Wilton range has attained the FIRA gold award.

### BOARD MATCHES

Oakgrain

The manufacturers board references listed below are for guidance only. Check colour samples from your board supplier for your own approval.

#### OAKGRAIN WHITE

Egger: W1200	Kronospan: 101
--------------	----------------

#### OAKGRAIN MUSSEL

Kronospan: 5982	Finsa: Gris Porrino 194
-----------------	-------------------------

#### OAKGRAIN CREAM

Egger: U104	Kronospan: U514	Finsa: Ivory Bama 65B
-------------	-----------------	-----------------------

#### OAKGRAIN GREY

Egger: U708	Pfleiderer: U1188
-------------	-------------------

#### OAKGRAIN DAKKAR

Egger: U717	Kronospan: 5984
-------------	-----------------

#### OAKGRAIN CASHMERE

Egger: U702	Kronospan: 5981	Pfleiderer: U1168	Finsa: Gris Coco 15R
-------------	-----------------	-------------------	----------------------

#### OAKGRAIN DUST GREY

Egger: U732	Kronospan: 0171
-------------	-----------------

#### OAKGRAIN GRAPHITE

Egger: U961
-------------

#### OAKGRAIN AZURE BLUE

Egger: U504
-------------

Made to measure sizes available on a 7 day lead time (see page 100-103).



Oakgrain White



Oakgrain Cream



Oakgrain Grey



Oakgrain Cashmere



Oakgrain Graphite



Oakgrain Dust Grey



Oakgrain Azure Blue



Oakgrain Dakkar

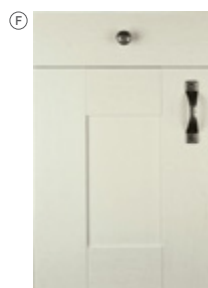

Oakgrain Mussel

#### Size H x W

110 x 596

140 x 296

140 x 396

140 x 446

140 x 496

140 x 596

140 x 796

140 x 896

140 x 996

175 x 396

175 x 496

175 x 596

283 x 496

283 x 596

283 x 796

283 x 896

283 x 996

355 x 496

355 x 596

355 x 796

355 x 896

355 x 996

450 x 596

490 x 596

#### Size H x W

570 x 296

570 x 396

570 x 446

570 x 496

570 x 596

645 x 596

715 x 146 (1 PC)

715 x 296

715 x 346

715 x 396

715 x 446

715 x 496

715 x 496  
Glazed Door

715 x 496  
Unglazed Frame

715 x 596

895 x 296

895 x 396

895 x 496

895 x 596

980 x 596

1245 x 296

1245 x 396

1245 x 496

1245 x 596

We offer a drilling service for your convenience. Hinge hole drilling is 35mm x 13mm deep.



# Wilton

## Range Accessories



**Pre Glued Edging Tape**  
22T x 50M  
(Not available in Oakgrain Azure Blue)

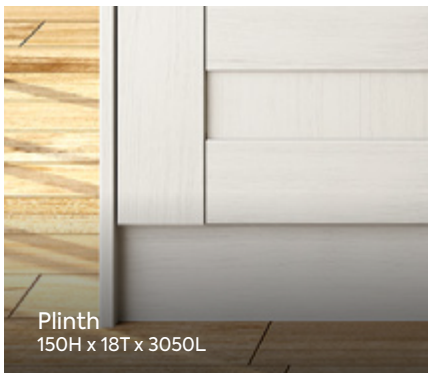

**Plinth**  
150H x 18T x 3050L

ⓔ



**Classic Cornice**  
3050L

ⓔ

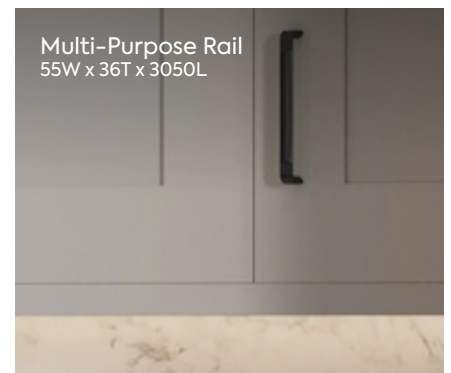

**Multi-Purpose Rail**  
55W x 36T x 3050L

ⓔ

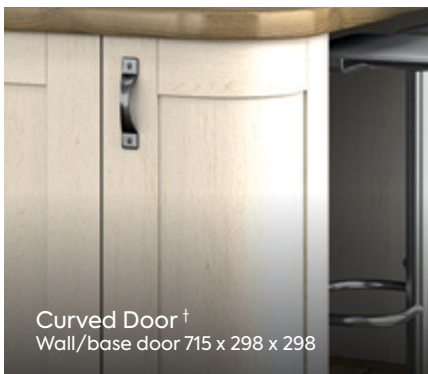

**Curved Door †**  
Wall/base door 715 x 298 x 298



**Curved Multi-Purpose Rail †**  
320 x 320 x 36T



**Curved Plinth †**  
150H x 300W x 560D

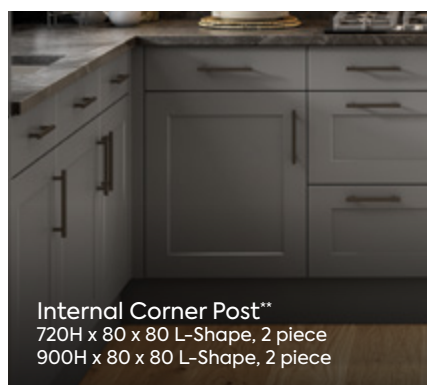

**Internal Corner Post\*\***  
720H x 80 x 80 L-Shape, 2 piece  
900H x 80 x 80 L-Shape, 2 piece

ⓔ

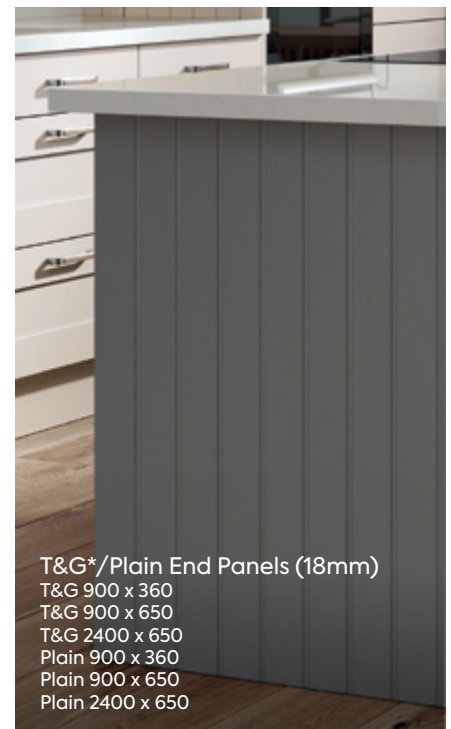

**T&G\*/Plain End Panels (18mm)**  
T&G 900 x 360  
T&G 900 x 650  
T&G 2400 x 650  
Plain 900 x 360  
Plain 900 x 650  
Plain 2400 x 650

ⓔ All colours except Oakgrain Dakkar, Oakgrain Graphite and Oakgrain Azure Blue.

\* Not available in Oakgrain White. \*\* See page 120 & 121 for corner planning details.  
† While stocks last. Please check with customer services before ordering.

# Stocked Doors

and Matching Accessories





# Lacarre

A stunning collection of standard sized kitchen doors and drawer fronts in a polyester high gloss finish.

- 22mm MDF 'J' Profile handleless door
- Choose from 2 gloss colours
- Available in standard sized doors, drawer fronts and matching accessories.
- In stock and despatched from 24 hours\*
- The Lacarre range carry a 6 year warranty.



24hr  
despatch



Product

Cert No. PC0051

FIRA Gold Certification is the ultimate mark of product excellence within the furniture industry and provides a solid reassurance that a product meets all necessary standards.

A selection of Lacarre doors have been tested by FIRA International and achieved FIRA Gold Certification Tests : **BS 6222-3**.

\*Please check communication updates on MyBA for live updates on lead times as they may fluctuate slightly during busy periods.

# Lacarre

## Range Doors



### RANGE SPECIFICATION

22mm MDF J Profile Handleless Door.  
Polyester Painted High Gloss Finish.

### CERTIFICATION

Products marked (F) are FSC® certified.

### BOARD MATCHES

Gloss

The manufacturers board references listed below are for guidance only. Check colour samples from your board supplier for your own approval.

#### GLOSS WHITE

Egger: **W1000**

#### GLOSS LIGHT GREY

Egger: **U708**

Kronospan: **0112**

Finsa: **U12 Natural Grey**

Pfleiderer: **U1188**

Note: When ordering Lacarre doors with hinge holes, specify handing and handle position.  
E.g. drill 100T 100B LH handle top.



Gloss White



Gloss Light Grey

#### Size H x W

140 x 296

140 x 396

140 x 446

140 x 496

140 x 596

140 x 796

140 x 896

140 x 996

175 x 396

175 x 496

175 x 596

283 x 496

283 x 596

283 x 796

283 x 896

283 x 996

355 x 496

355 x 596

355 x 796

355 x 896

355 x 996

450 x 596

490 x 596

570 x 296

#### Size H x W

570 x 396

570 x 446

570 x 496

570 x 596

645 x 596

715 x 146

715 x 236

715 x 296

715 x 346

715 x 396

715 x 446

715 x 496

715 x 596

895 x 236

895 x 296

895 x 396

895 x 496

895 x 596

980 x 596

1245 x 296

1245 x 396

1245 x 496

1245 x 596

# Lacarre

## Range Accessories



**Plinth**  
150H x 18T x 3000L



**Internal Curved Plinth\*\***  
150H x 404W x 404D



**External Curved Door\*\***  
Wall/base door 715 x 298 x 298



**External Curved Plinth\*\***  
150H x 300W x 560D



**External Curved Multi-Purpose Rail\*\***  
320 x 320 x 36T

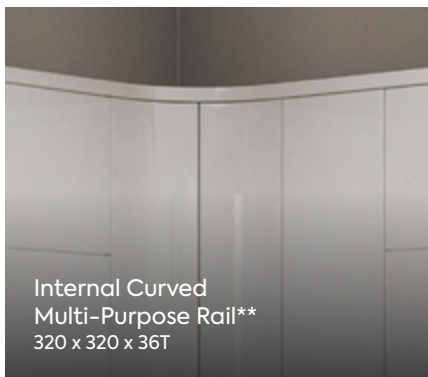

**Internal Curved Multi-Purpose Rail\*\***  
320 x 320 x 36T



**Multi-Purpose Rail**  
55W x 36T x 3050L

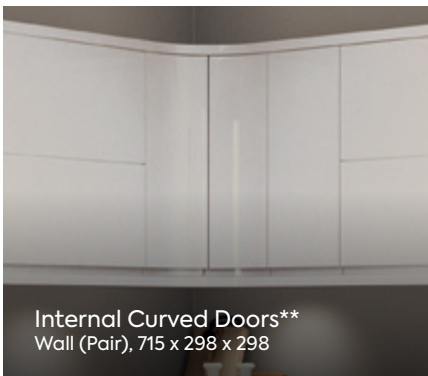

**Internal Curved Doors\*\***  
Wall (Pair), 715 x 298 x 298

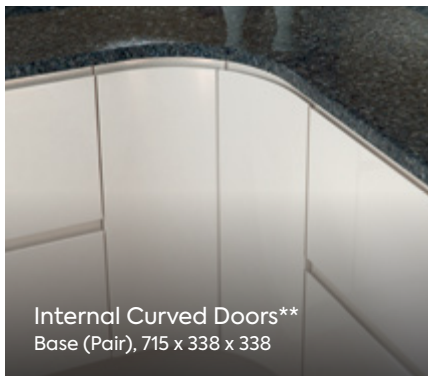

**Internal Curved Doors\*\***  
Base (Pair), 715 x 338 x 338



**Square End Panel (22mm)**  
900H x 360W  
900H x 650W  
2400H x 650W

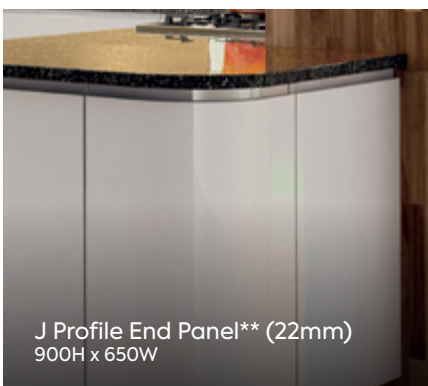

**J Profile End Panel\*\* (22mm)**  
900H x 650W

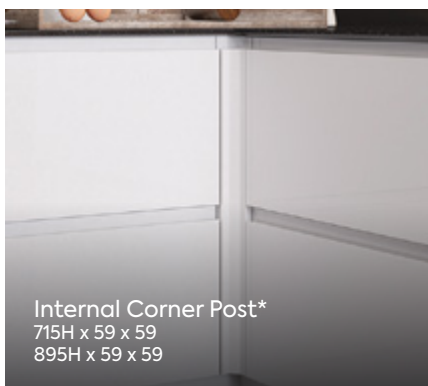

**Internal Corner Post\***  
715H x 59 x 59  
895H x 59 x 59



**External Corner Post**  
900H x 59 x 59



**Pre Glued Edging Tape**  
22T x 50M  
(Matt Finish)

\* See page 120 & 121 for corner planning details.

\*\* Limited availability. Please check with customer services before ordering.

# Stocked Doors and Matching Accessories





# Thornbury

A stunning collection of standard sized kitchen doors and drawer fronts. This classic shaker style, through the addition of an elegant bead, combines perfectly with a calming natural colour palette.

- 20mm 5 piece solid ash timber frame beaded door
- Choose from 4 painted colours
- Available in standard sized doors, drawer fronts and matching accessories.
- In stock and despatched within 10 days\*
- The Thornbury range carry a 6 year warranty.



10 day  
despatch



Cert No. PC0051

FIRA Gold Certification is the ultimate mark of product excellence within the furniture industry and provides a solid reassurance that a product meets all necessary standards.

A selection of Thornbury doors have been tested by FIRA International and achieved FIRA Gold Certification Tests : **BS 6222-3**.

\*Please check communication updates on MyBA for live updates on lead times as they may fluctuate slightly during busy periods.

# Thornbury

## Range Doors



### RANGE SPECIFICATION

20mm 5-piece solid ash timber frame with veneered centre panel and beaded detail. Matt painted. Despatched within 10 working days.

### CERTIFICATION

The Thornbury range has attained the FIRA gold award.

### BOARD MATCHES

The manufacturers board references listed below are for guidance only. Check colour samples from your board supplier for your own approval.

#### PORCELAIN

Egger: **W1200**

#### DOVE GREY

Egger: **U708** | Kronospan: **0112**

#### STONE

Egger: **U201**

#### DUST GREY

Egger: **U732** | Kronospan: **0171**



Porcelain

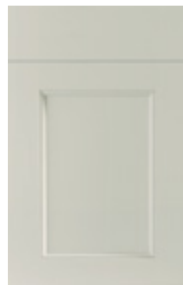

Dove Grey



Stone



Dust Grey

#### Size H x W

115 x 596

140 x 296

140 x 396

140 x 446

140 x 496

140 x 596

140 x 796

140 x 896

140 x 996

175 x 496

175 x 596

283 x 496

283 x 596

283 x 796

283 x 896

283 x 996

355 x 496

355 x 596

355 x 796

355 x 896

355 x 996

450 x 596

490 x 396

490 x 596

570 x 296

570 x 396

570 x 446

#### Size H x W

570 x 496

570 x 596

645 x 596

715 x 146

715 x 256

715 x 296

715 x 325

715 x 346

715 x 396

715 x 396 Clear Glazed

715 x 446

715 x 496

715 x 496 Clear Glazed

715 x 546

715 x 596

895 x 296

895 x 396

895 x 446

895 x 496

895 x 496 Clear Glazed

895 x 596

980 x 596

1245 x 296

1245 x 396

1245 x 496

1245 x 596

1965 x 296

We offer a drilling service for your convenience (allow additional day for this service). Thornbury doors have a limited number of drilling positions, please see MyBA for full listing. Hinge hole drilling is 35mm x 13mm deep.



# Thornbury

## Range Accessories



**Cornice**  
130H x 36.5T x 3030L

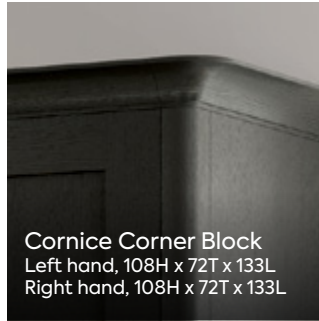

**Cornice Corner Block**  
Left hand, 108H x 72T x 133L  
Right hand, 108H x 72T x 133L

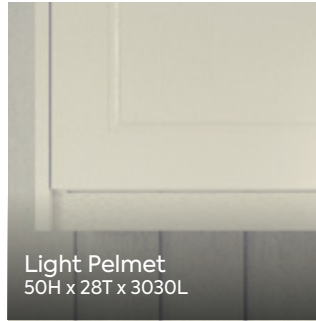

**Light Pelmet**  
50H x 28T x 3030L

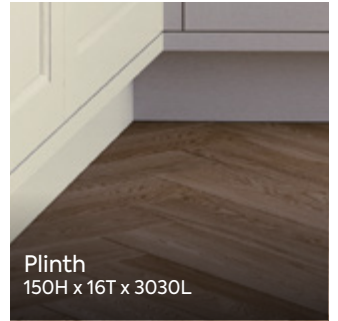

**Plinth**  
150H x 16T x 3030L

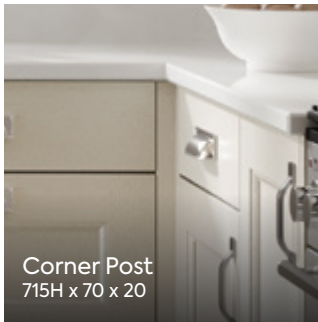

**Corner Post**  
715H x 70 x 20

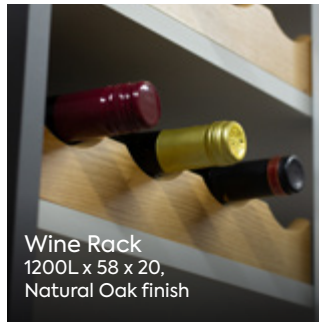

**Wine Rack**  
1200L x 58 x 20,  
Natural Oak finish

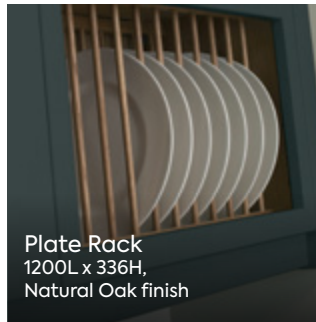

**Plate Rack**  
1200L x 336H,  
Natural Oak finish

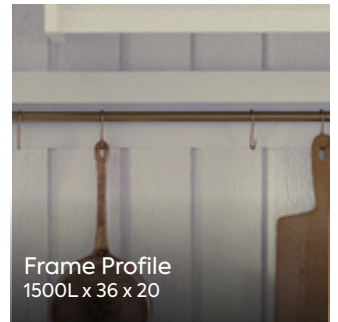

**Frame Profile**  
1500L x 36 x 20



**Tall Square Feature End**  
2400H x 75T x 50W

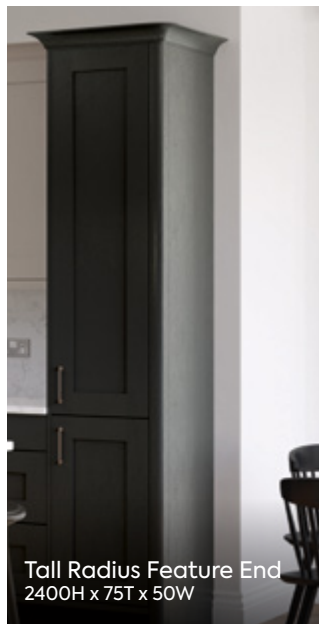

**Tall Radius Feature End**  
2400H x 75T x 50W



**T&G End Panel**  
774H x 370W x 18T,  
954H x 370W x 18T,  
900H x 650W x 18T  
2400H x 650W x 18T

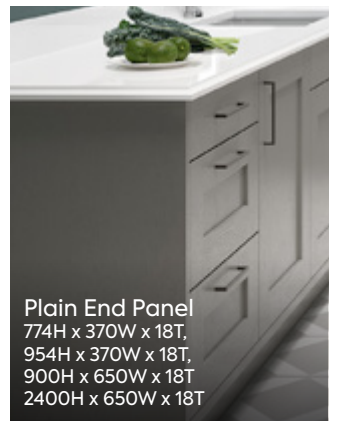

**Plain End Panel**  
774H x 370W x 18T,  
954H x 370W x 18T,  
900H x 650W x 18T  
2400H x 650W x 18T



**Un-glued Veneer Edging Tape**  
22mmT x 3M



**Painted Door After Care Kit**  
Specify name and colour

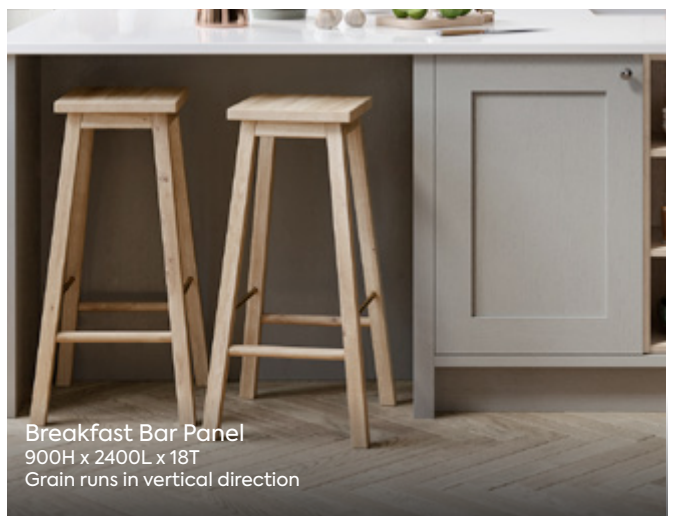

**Breakfast Bar Panel**  
900H x 2400L x 18T  
Grain runs in vertical direction

# Stocked Doors

and Matching Accessories





# Hadley

A stunning collection of standard sized kitchen doors and drawer fronts. This timeless classic, simple yet elegant, offers a contemporary feel in a traditional kitchen.

- 20mm 5 piece solid ash timber frame door
- Choose from 6 painted colours
- Available in standard sized doors, drawer fronts and matching accessories.
- In stock and despatched within 10 days\*
- The Hadley range carry a 6 year warranty.



10 day  
despatch



Product

Cert No. PC0051

FIRA Gold Certification is the ultimate mark of product excellence within the furniture industry and provides a solid reassurance that a product meets all necessary standards.

A selection of Hadley doors have been tested by FIRA International and achieved FIRA Gold Certification Tests : **BS 6222-3**.

\*Please check communication updates on MyBA for live updates on lead times as they may fluctuate slightly during busy periods.

## RANGE SPECIFICATION

20mm 5-piece solid ash timber frame and veneered centre panel. Matt painted. Despatched within 10 working days.

## CERTIFICATION

The Hadley range has attained the FIRA gold award.

## BOARD MATCHES

The manufacturers board references listed below are for guidance only. Check colour samples from your board supplier for your own approval.

### PORCELAIN

Egger: **W1200**

### EARL GREY

We suggest a contrasting finish or alternative woodgrain effect board

### DOVE GREY

Egger: **U708**

Kronospan: **0112**

### STONE

Egger: **U201**

### DUST GREY

Egger: **U732**

Kronospan: **0171**

### GRAPHITE

Egger: **U961**

Kronospan: **0164**

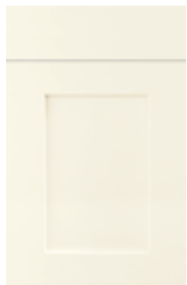

Porcelain



Earl Grey



Dove Grey



Stone



Dust Grey



Graphite

### Size H x W

115 x 596

140 x 296

140 x 396

140 x 446

140 x 496

140 x 596

140 x 796

140 x 896

140 x 996

175 x 496

175 x 596

283 x 496

283 x 596

283 x 796

283 x 896

283 x 996

355 x 496

355 x 596

355 x 796

355 x 896

355 x 996

450 x 596

490 x 396

490 x 596

570 x 296

570 x 396

570 x 446

### Size H x W

570 x 496

570 x 596

645 x 596

715 x 146

715 x 256

715 x 296

715 x 325

715 x 346

715 x 396

715 x 396 Clear Glazed

715 x 446

715 x 496

715 x 496 Clear Glazed

715 x 546

715 x 596

895 x 296

895 x 396

895 x 446

895 x 496

895 x 496 Clear Glazed

895 x 596

980 x 596

1245 x 296

1245 x 396

1245 x 496

1245 x 596

1965 x 296

# Hadley

## Range Accessories



**Cornice**  
130H x 36.5T x 3030L

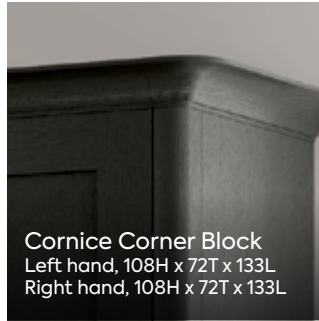

**Cornice Corner Block**  
Left hand, 108H x 72T x 133L  
Right hand, 108H x 72T x 133L

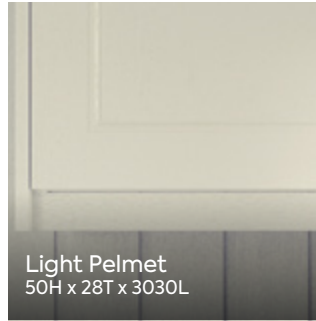

**Light Pelmet**  
50H x 28T x 3030L

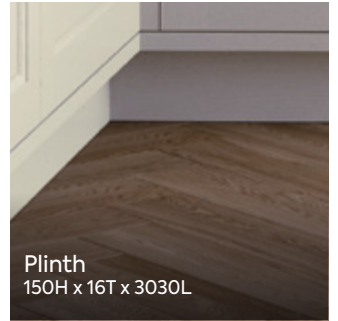

**Plinth**  
150H x 16T x 3030L

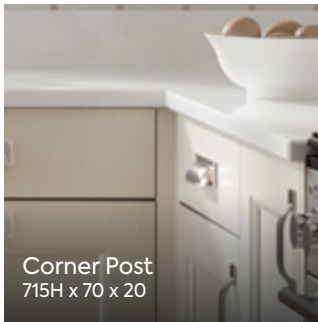

**Corner Post**  
715H x 70 x 20

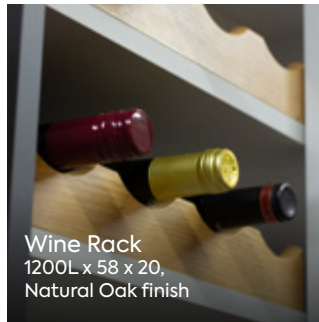

**Wine Rack**  
1200L x 58 x 20,  
Natural Oak finish

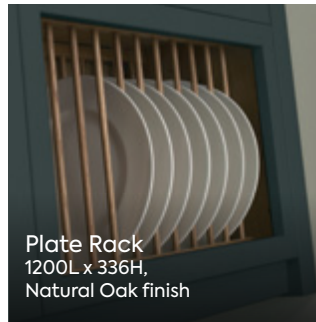

**Plate Rack**  
1200L x 336H,  
Natural Oak finish

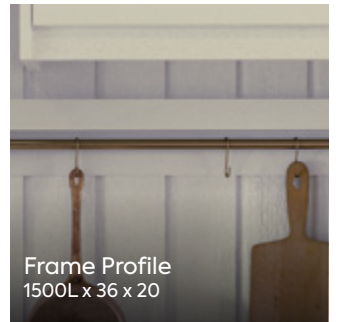

**Frame Profile**  
1500L x 36 x 20



**Tall Square Feature End**  
2400H x 75T x 50W



**Tall Radius Feature End**  
2400H x 75T x 50W

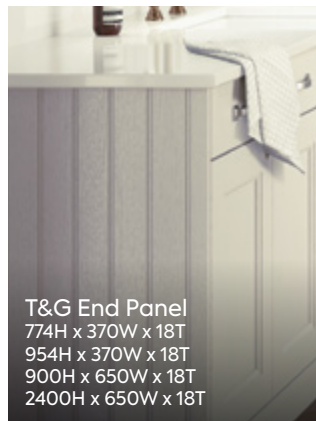

**T&G End Panel**  
774H x 370W x 18T  
954H x 370W x 18T  
900H x 650W x 18T  
2400H x 650W x 18T

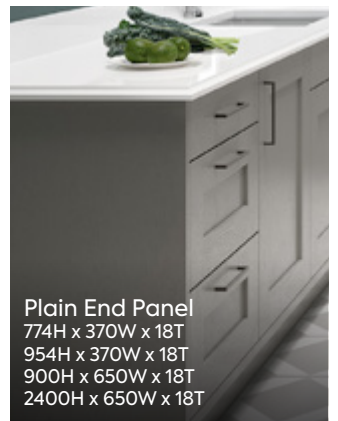

**Plain End Panel**  
774H x 370W x 18T  
954H x 370W x 18T  
900H x 650W x 18T  
2400H x 650W x 18T



**Un-glued Veneer Edging Tape**  
22mmT x 3M



**Painted Door After Care Kit**  
Specify name and colour

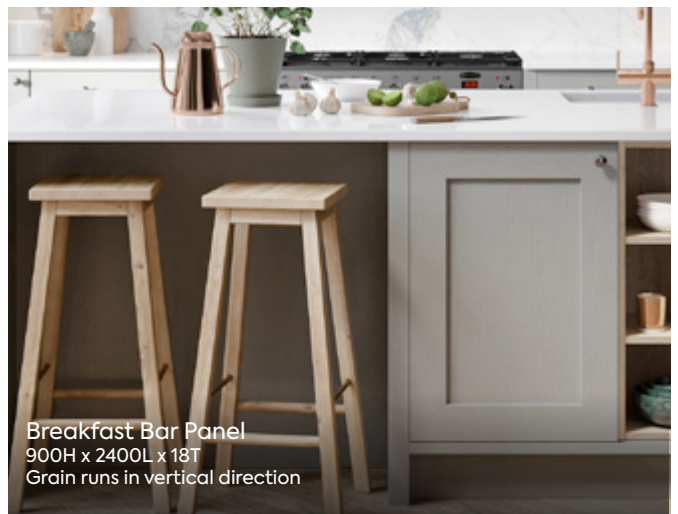

**Breakfast Bar Panel**  
900H x 2400L x 18T  
Grain runs in vertical direction

# Made to Measure Doors and Matching Accessories





# Made to Measure Doors and Matching Accessories

With over 30 years experience in the manufacture of kitchen and bedroom components, BA has an extensive range of made to measure doors on fast lead times with on-trend matching accessories. Bespoke is standard for us at BA as we cater for the needs of our network of independent retailers and their customers.

\*Please check communication updates on MyBA for live updates on lead times as they may fluctuate slightly during busy periods.

# Made to Measure Doors\*

## Range Overview



### Valore Range

p64-69

An 18mm MFC cut and edged slab door available in 16 colours with matching reverse.

**Please Note:**  
Selection shown – please see Valore section for all colours available.

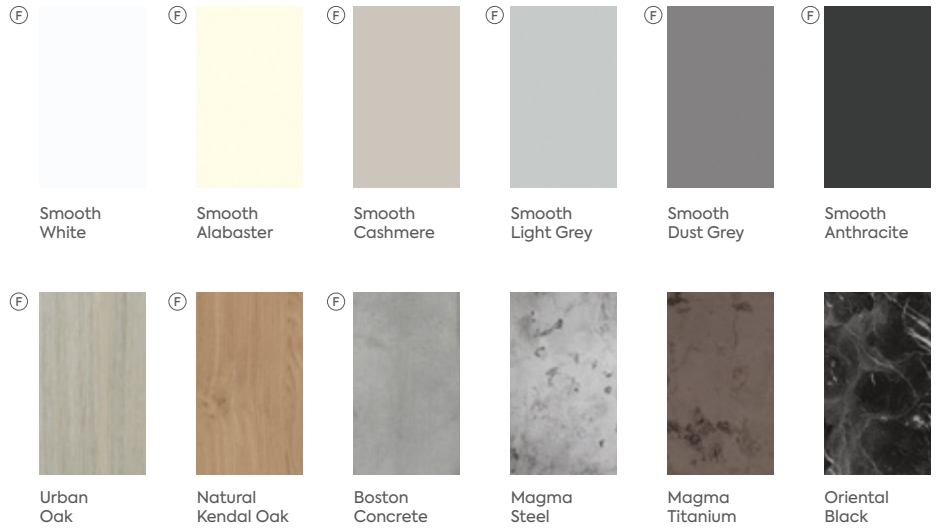

### Bella Range

p70-91

An 18mm MDF vinyl wrapped range in 39 colours and 29 styles. Any colour, any style and any size this range is the door choice for many BA dealers.

**Please Note:**  
Selection shown – please see Bella section for all colours and styles available.



### Jayline Range

p92-95

A 19mm MDF J Profile handleless door, available in a range of 11 stunning supermatt and supergloss colours. Has a full wrap door with a continuous laminate on the top edge and face. All colour options have matching melamine reverse.





## Firbeck Range

p96-99

A 18mm MDF slab door with matching edging in a range of 11 stunning supermatt and supergloss colours. All colour options have matching melamine reverse.



Supergloss White    Supergloss Light Grey    Supergloss Cashmere    Supergloss Dust Grey    Supergloss Graphite



Supermatt White    Supermatt Light Grey    Supermatt Cashmere    Supermatt Dust Grey    Supermatt Graphite    Supermatt Indigo Blue

## Wilton Range

p100-103

9 colours are available in this 5-piece door construction. The frames are 120mm W x 22mm MDF. Panels are 6mm. Drawer fronts are 1 piece 22mm. Doors and drawers have a 2mm chamfered edge.

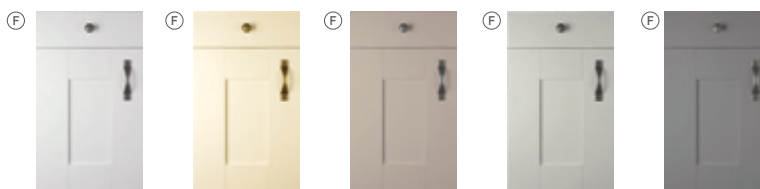

Oakgrain White    Oakgrain Cream    Oakgrain Cashmere    Oakgrain Grey    Oakgrain Dust Grey

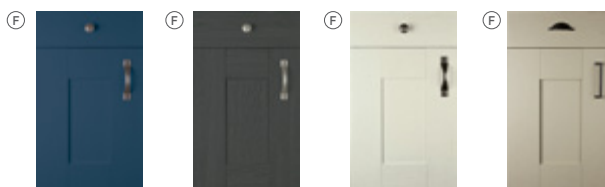

Oakgrain Azure Blue    Oakgrain Graphite    Oakgrain Mussel    Oakgrain Dakkar

## Zurfiz Range

p104-111

An 18mm MDF and MFC range of ultra modern doors available in 26 colour with the choice of 3 edge options for added flexibility.

### Please Note:

Selection shown - please see Zurfiz section for all ranges available.

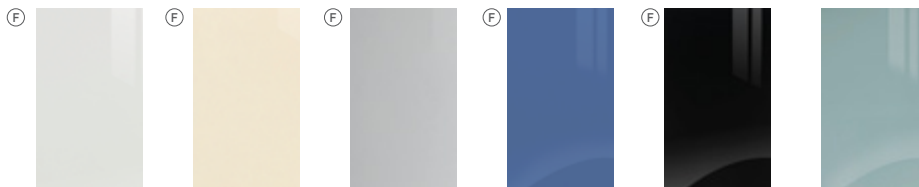

Ultragloss Glacier White    Ultragloss Cream    Ultragloss Light Grey    Ultragloss Baltic Blue    Ultragloss Black    Ultragloss Metallic Blue



Supermatt White    Supermatt Light Grey    Supermatt Graphite    Supermatt Taupe    Supermatt Plum    Copperleaf

# Made to Measure Doors and Matching Accessories





# Valore

A range of 16 great value MFC cut and edged slab doors that look a million dollars. On trend finishes made to an exceptional quality make Valore the final piece in the BA retailer jigsaw.

Where great value means great design.

- A value for money range of MFC edged doors.
- Available in kitchen, bedroom, bathroom and non standard sizes.
- 18mm MFC range of colours with 2 edge options.
- A selection of Valore doors are FSC® certified and have attained the FIRA gold award.
- The Valore range carries a 6 year guarantee.
- Manufactured and despatched within 7 working days.



Cert No. PC0051

FIRA Gold Certification is the ultimate mark of product excellence within the furniture industry and provides a solid reassurance that a product meets all necessary standards.

A selection of Valore doors have been tested by FIRA International and achieved FIRA Gold Certification Tests : **BS 6222-3**.

### All colours have matching front and back melamine.

The manufacturers board references listed are for guidance only. Check colour samples from your board supplier for your own approval.



### CERTIFICATION

Products marked (F) are FSC® certified.

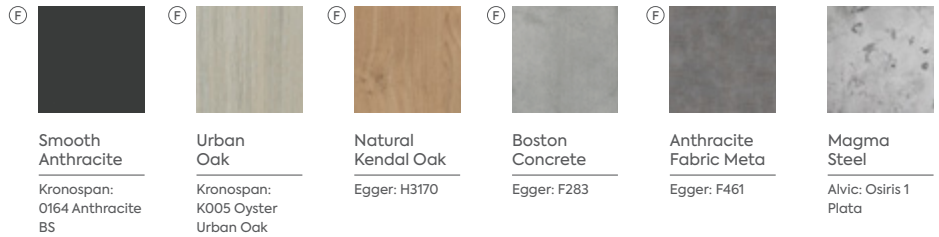

**Note for woodgrain/patterned finishes:**  
Due to variance in pattern repeat and production processes we cannot guarantee a matched pattern/book match on door runs/combinations or drawer packs.

\*Please note colour swatches represented in this document are for reference only and final purchasing decisions should only be made after viewing a physical swatch or sample door (see page 143).

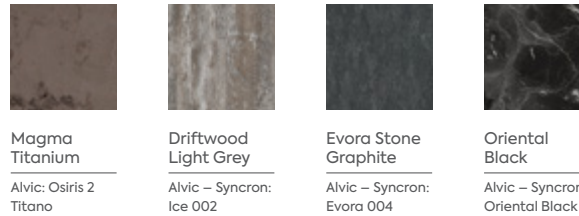

## General Accessories



### Internal Corner Post

720H x 80 x 80 L-Shape, 2 piece  
Code: **AVCORNER80**

900H x 80 x 80 L-Shape, 2 piece  
Code: **AVCORNER980**



### Plinth\*\*

Plinth is available in any height between 100mm and 150mm x 2750mm long except Magma Steel, Magma Titanium, Driftwood Light Grey, Evora Stone Graphite and Oriental Black - 2715mm long. Supplied with matching edging edged on one long edge.

Code: **AVPLINTH**



### End Panels

Edged 4 sides - edging supplied as doors ordered, unless specified  
900 x 350mm Code: **AVP900x350**  
900 x 650mm Code: **AVP900x650**  
2400 x 650mm Code: **AVP2400x650**

**Non Standard Panels/Tops\*\*** (edged 4 sides)  
Available any size from 100 > 2750mm L x 100 > 1200mm W. Code: **AVEP**

**Raw Edge Panels\*\*** (not edged)  
Available any size from 100 > 2750mm L x 100 > 1200mm W. Code: **AVUNEP**

\*\*Magma Steel, Magma Titanium, Driftwood Light Grey, Evora Stone Graphite and Oriental Black only available up to 2715mm long.

# Valore

## Wrap Around End Panels

- All panels are 18mm thick and when constructed will have no visible raw edges.
- All panels supplied with a doweled Butt joint for easy assembly.
- Handleless Rail End Panels - use C-Panel with depth of 45mm.
- All panels are vertical grain unless otherwise specified.
- G-Panel for widths 400mm or less returns should be 100mm.

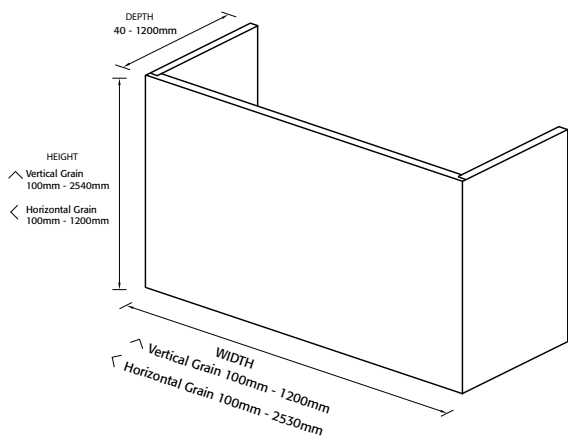

### Wrap Around C-Panel

Price per m2 (3 panels)  
 Code: **AVPWAC**

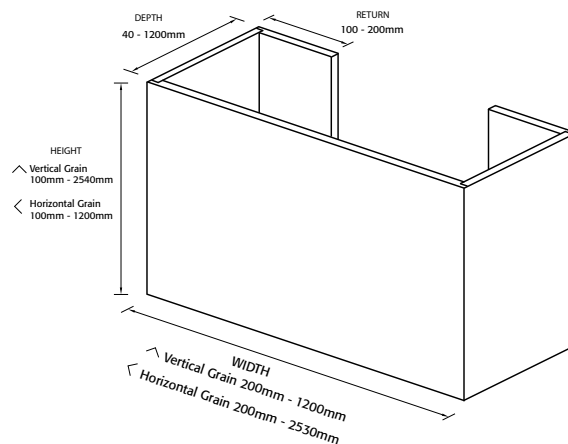

### Wrap Around G-Panel

Price per m2 (5 panels)  
 Code: **AVPWAG**



### Hinged Corner Post

715mm. Complete with all fixings.  
 Note: Reduce door widths as illustration.  
 Stainless steel Code: **AHCPSS**  
 Satin chrome Code: **AHCPSC**

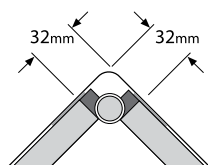

### Edging Tape

22mm W melamine edging supplied unglued.  
 75m Roll - Alabaster, Anthracite, Anthracite Fabric Metal, Boston Concrete and Natural Kendal Oak  
 150m Roll - White, Cashmere, Fjord, Light Grey, Dust Grey  
 200m Roll - Urban Oak  
 225m Roll - Magma Steel, Magma Titanium, Evora Stone Graphite, Oriental Black and Driftwood Light Grey

Code: **AVMATCHEDG75**  
 Code: **AVMATCHEDG150**  
 Code: **AVMATCHEDG200**  
 Code: **AVMATCHEDG225**  
 Code: **AVPLYWEDGE**  
 10m Roll Plywood Effect

### Technical specification

- All doors and drawer fronts are 18mm thick.
- Available in any size within the specifications below.
- Minimum height 100mm, maximum height 2750mm.
- Minimum width 100mm, maximum width 1200mm.
- Woodgrain direction on drawer fronts is horizontal – 100mm – 282mm High.
- Woodgrain direction on doors is vertical – 283mm High and above.
- Horizontal woodgrain can be supplied on doors up to 2000mm High, please specify when ordering.
- See page 66 for details of colours and board matches.

Size H x W	Size H x W	Size H x W	Size H x W	Size H x W
115 x 396	355 x 796	715 x 796	1245 x 596	2155 x 296
115 x 496	355 x 896	715 x 996	1245 x 796	2155 x 396
115 x 596	355 x 996	715 x 1200	1245 x 996	2155 x 446
140 x 296	415 x 396	895 x 296	1245 x 1200	2155 x 496
140 x 396	415 x 446	895 x 396	1375 x 396	2155 x 596
140 x 446	415 x 496	895 x 446	1375 x 496	2155 x 796
140 x 496	415 x 596	895 x 496	1435 x 396	2155 x 996
140 x 596	450 x 596	895 x 596	1435 x 496	2155 x 1200
140 x 796	490 x 596	900 x 296	1435 x 796	2250 x 296
140 x 896	535 x 396	900 x 396	1435 x 996	2250 x 396
140 x 996	535 x 496	900 x 446	1435 x 1200	2250 x 446
175 x 396	570 x 296	900 x 496	1450 x 396	2250 x 496
175 x 496	570 x 396	900 x 596	1450 x 496	2250 x 596
175 x 596	570 x 446	900 x 796	1495 x 396	2400 x 296
175 x 796	570 x 496	900 x 996	1495 x 446	2400 x 396
175 x 996	570 x 596	900 x 1200	1495 x 496	2400 x 446
215 x 396	645 x 596	980 x 596	1495 x 596	2400 x 496
215 x 496	650 x 296	1055 x 396	1495 x 796	2400 x 596
215 x 596	650 x 396	1055 x 446	1495 x 996	2540 x 296
215 x 796	650 x 446	1055 x 496	1495 x 1200	2540 x 396
215 x 996	650 x 496	1055 x 596	1735 x 296	2540 x 446
283 x 496	650 x 596	1060 x 396	1735 x 396	2540 x 496
283 x 596	715 x 146	1060 x 446	1735 x 446	2540 x 596
283 x 796	715 x 296	1060 x 496	1735 x 496	2540 x 796
283 x 896	715 x 396	1060 x 596	1735 x 596	2540 x 996
283 x 996	715 x 446	1245 x 296	1735 x 796	2540 x 1200
355 x 496	715 x 496	1245 x 396	1735 x 996	
355 x 596	715 x 596	1245 x 496	1735 x 1200	

### STANDARD SIZES

Above shows standard size kitchen and bedroom doors and drawer fronts available in all 16 colours.

### MADE TO MEASURE DOOR SURCHARGES

For Pricing of Non Standard Size Doors and Drawer Fronts, use next standard size up and add 10%.

### HINGE HOLES

35mm diameter x 13mm depth.

### Valore Edge Options

The Valore range is available in 2 edge options:



Matching



Plywood Effect



# Made to Measure Doors and Matching Accessories







# Bella

The Bella Range has been leading the way in the KBB market for over 24 years and is much loved by all customers old and new. A fully made-to-measure range in 39 colours and 29 styles it has something for every taste.

Any colour, any style, any size and despatched within 7 days truly reflects the versatility of the Bella range. From high gloss to matt, solid colours to beautiful woodgrains, Bella is the door of choice for many BA dealers.

- Market leader in made to measure vinyl wrapped doors.
- Available in kitchen, bedroom, bathroom, sloping and non standard sizes.
- Available in 39 colour options and 29 door styles.
- Complemented with a wide range of matching accessories.
- 18mm MDF with vinyl wrapped surface finishes in matt and gloss PVC and PET.
- A selection of Bella doors are FSC® or PEFC certified and a selection have attained the FIRA gold award.
- The Bella range carries a 6 year guarantee.
- Manufactured and despatched within 7 working days.



Cert No. PC0051

FIRA Gold Certification is the ultimate mark of product excellence within the furniture industry and provides a solid reassurance that a product meets all necessary standards.

A selection of Bella doors have been tested by FIRA International and achieved FIRA Gold Certification Tests : BS 6222-3.

The manufacturers board references listed below are for guidance only. Check colour samples from your board supplier for your own approval. As an alternative to matching melamine boards we can supply you with matching vinyl wrapped panels or matching self adhesive vinyl (see pages 85 & 89). Note: The backs of High Gloss Colours are standard matt finish.

					
<p><b>High Gloss White</b></p> <p>Back Colour: <b>Matching</b>            Egger: <b>W980</b>            Kronospan: <b>K101</b>            Pfleiderer: <b>W300</b>            Finsa: <b>White 020</b></p>	<p><b>High Gloss Cream</b></p> <p>Back Colour: <b>Matching</b>            Egger: <b>U104</b>            Kronospan: <b>U514 or 7031</b>            Pfleiderer: <b>U1306</b>            Finsa: <b>Contempo Ivory 65B</b></p>	<p><b>High Gloss Light Grey</b></p> <p>Back Colour: <b>Matching</b>            Egger: <b>U708</b>            Kronospan: <b>0112</b>            Pfleiderer: <b>U1188</b>            Finsa: <b>U12 Natural Grey</b></p>	<p><b>High Gloss Dust Grey</b></p> <p>Back Colour: <b>Matching</b>            Egger: <b>U732</b>            Kronospan: <b>0171 Slate Grey</b>            Pfleiderer: <b>U12150</b>            Finsa: <b>Gris Tormenta 09F</b></p>	<p><b>High Gloss Cashmere</b></p> <p>Back Colour: <b>Matching</b>            Egger: <b>U702</b>            Kronospan: <b>5981</b>            Pfleiderer: <b>U1168</b>            Finsa: <b>Gris Coco 15R</b></p>	<p><b>Porcelain White</b></p> <p>Back Colour: Matching            Egger: W1100            Alpine white</p>
					
<p><b>Satin White</b></p> <p>Back Colour: Matching            Egger: W980            Kronospan: K101            Pfleiderer: W300            Finsa: White 020</p>	<p><b>Super White Ash</b></p> <p>Back Colour: Matching            Egger: W980            Kronospan: K101            Pfleiderer: W300            Finsa: White 020</p>	<p><b>Alabaster</b></p> <p>Back Colour: Matching            Egger: U104            Kronospan: U514            Pfleiderer: U1303            Finsa: Contempo Ivory 65B</p>	<p><b>Ivory</b></p> <p>Back Colour: Matching            Egger: U222            Kronospan: U564            Pfleiderer: U1358            Finsa: Crema 005</p>	<p><b>Vanilla</b></p> <p>Back Colour: Matching            Egger: U108            Kronospan: U9569            Pfleiderer: U116</p>	<p><b>Opengrain White</b></p> <p>Back Colour: Matching            Egger: W980            Kronospan: K101            Pfleiderer: W300            Finsa: White 020</p>
					
<p><b>Oakgrain Cream</b></p> <p>Back Colour: Matching            Egger: U104            Kronospan: U514            Pfleiderer: U1303            Finsa: Contempo Ivory 65B</p>	<p><b>Oakgrain Mussel</b></p> <p>Back Colour: Matching            Pfleiderer: U1331            Finsa: Gris Porrino 194</p>	<p><b>Oakgrain Cashmere</b></p> <p>Back Colour: Matching            Egger: U702            Kronospan: 5981            Pfleiderer: U1168            Finsa: Gris Coco 15R</p>	<p><b>Oakgrain Grey</b></p> <p>Back Colour: Matching            Egger: U708            Kronospan: 0112            Finsa: U12 Natural Grey            Pfleiderer: U1188</p>	<p><b>Matt Mussel</b></p> <p>Back Colour: Matching            Kronospan: 5982            Pfleiderer: U1331            Finsa: Gris Porrino 194</p>	<p><b>Matt Pebble</b></p> <p>Back Colour: Matching            Egger: U201</p>
					
<p><b>Matt Dove Grey</b></p> <p>Back Colour: Matching            Egger: U708            Kronospan: 0112            Finsa: U12 Natural Grey            Pfleiderer: U1188</p>	<p><b>Matt Dakkar</b></p> <p>Back Colour: Matching            Egger: U717            Kronospan: 5984            Pfleiderer: U1190            Finsa: Duna 20R</p>	<p><b>Matt Taupe</b></p> <p>Back Colour: Matching            Egger: U741 ST9</p>	<p><b>Matt Stone Grey</b></p> <p>Back Colour: Matching            Egger: U727            Kronospan: K096            Finsa: 40Y Mineral Grey            Pfleiderer: U1184</p>	<p><b>Matt Denim</b></p> <p>Back Colour: Matching            Egger: U540            Pfleiderer: U18002 (U1717)</p>	<p><b>Matt Blush Pink</b></p> <p>Back Colour: Matching            Egger: U325</p>



The following door styles are not available in gloss colours: Aldridge, Austin, Buxton, Chester, Elland, Euroline, Helmsley, Integra, Knebworth, Newport, Oakham, Segreto, Shaker, Stratford, Surrey, Tullymore, Warwick and Westbury.



**Matt Colonial Blue**

Back Colour: Matching  
Kronospan: 5994 Albany Blue



**Matt Sage Green**

Back Colour: Matching  
Egger: U604 Reed Green

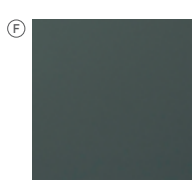

**Matt Kombu Green**

Back Colour: Matching  
Pfleiderer: U19008

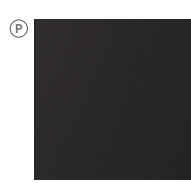

**Matt Black**

Back Colour: Matching  
Egger: U999  
Finsa: Negro

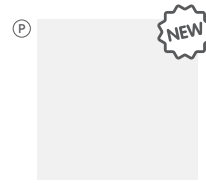

**Supermatt White**

Back Colour: Matching  
Kronospan: 8100 Pearl White



**Supermatt Cashmere**

Back Colour: Matching  
Egger: U702  
Kronospan: 5981  
Pfleiderer: U1168  
Finsa: Gris Coco 15R



**Supermatt Light Grey**

Back Colour: Matching  
Egger: U708  
Kronospan: 0112  
Finsa: U12 Natural Grey  
Pfleiderer: U1188



**Supermatt Dust Grey**

Back Colour: Matching  
Egger: U732  
Kronospan: 0171 Slate Grey  
Finsa: Gris Tormenta 09F  
Pfleiderer: U12150



**Supermatt Graphite**

Back Colour: Matching  
Egger: U961



**Supermatt Indigo Blue**

Back Colour: Matching  
Pfleiderer: U17500

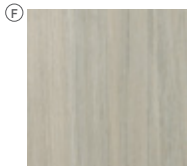

**Urban Oak**

Back Colour: Matching  
Kronospan: K005  
Oyster  
Urban Oak

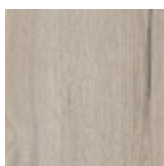

**Halifax White Oak**

Back Colour: Matching  
Egger: H1176 ST22

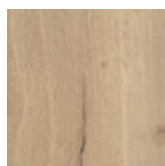

**Halifax Natural Oak**

Back Colour: Matching  
Egger: H1180 ST22



**Lissa Oak**

Back Colour: Matching  
Kronospan: D8925  
Pfleiderer: R4276  
Finsa: 49D

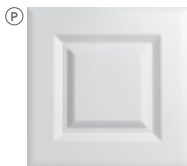

**Paintable**

Back Colour: Light Grey  
Use matching vinyl wrapped panels or self adhesive vinyl (see pages 84 & 89).



## Paintable Vinyl

Paintable vinyl is suitable for hand or spray painting.

For details on paint type, application or approved painting service companies see page 146 for Help & Support.

## BOARD MANUFACTURERS DISTRIBUTOR DETAILS:

[www.eggerstockists.com/product-type-search.php](http://www.eggerstockists.com/product-type-search.php)

[www.pfleiderer.co.uk/distributors](http://www.pfleiderer.co.uk/distributors)

[www.finsa.com](http://www.finsa.com) (click tools, click distributors, click Superpan Tech)

Contact Kronospan on Tel: **01691 773361**

## CERTIFICATIONS

Colours marked **(P)** are PEFC Certified.

Colours marked **(F)** are FSC Certified.

# Bella

## Door Styles & Specifications

**NEW**  
New styles available

**Made to Measure**

**7**  
7 day despatch

### STYLE SPECIFICATIONS

(Unless specified at individual door style)

#### Drawer Fronts

Min H 60mm, Max H 282mm.  
Min W 100mm, Max W 1200mm.

#### Standard Doors

Min H 283mm, Max H 1699mm.  
Min W 100mm, Max W 1200mm.

#### Tall Doors

Min H 1700mm, Max H 2540mm.  
Min W 100mm, Max W 1200mm W.  
Max door size is 2540mm H x 1200mm W.

Tall door designs with two panels will be supplied with the mid rail at 655mm from the bottom edge to the centre of the mid rail as standard unless otherwise specified.

#### Doors for Corner Cabinets

Doors can be supplied with either the left or right side edge square. Available up to Max. 1699mm H.

### Aldridge

(Not available in High Gloss Colours)

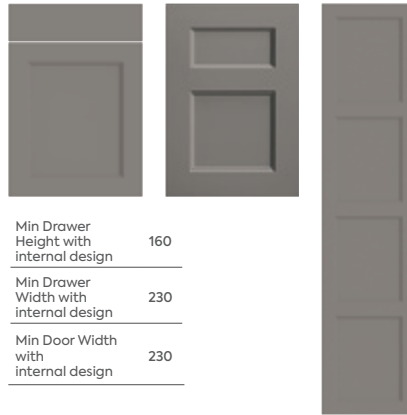

Min Drawer Height with internal design	160
Min Drawer Width with internal design	230
Min Door Width with internal design	230

### Ashford

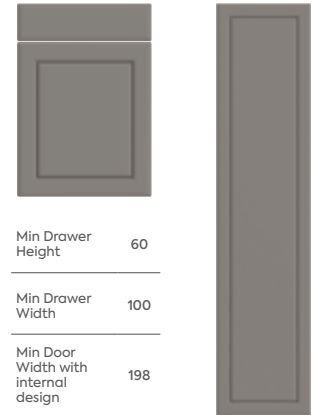

Min Drawer Height	60
Min Drawer Width	100
Min Door Width with internal design	198

For detailed door panel configurations on this style please download the Technical Specification from MyBA or contact Customer Services.

### Austin

(Not available in High Gloss Colours)

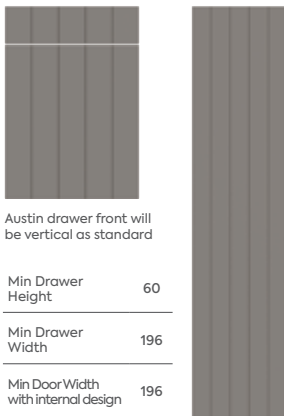

Austin drawer front will be vertical as standard

Min Drawer Height	60
Min Drawer Width	196
Min Door Width with internal design	196

### Buxton

(Not available in High Gloss Colours)

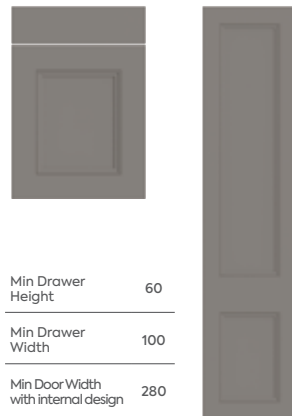

Min Drawer Height	60
Min Drawer Width	100
Min Door Width with internal design	280

### Cambridge

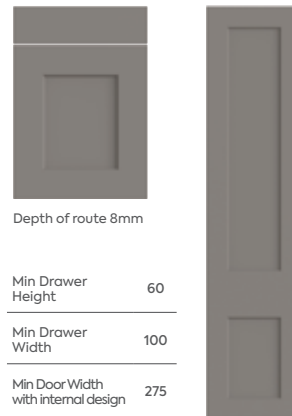

Depth of route 8mm

Min Drawer Height	60
Min Drawer Width	100
Min Door Width with internal design	275

### Canterbury

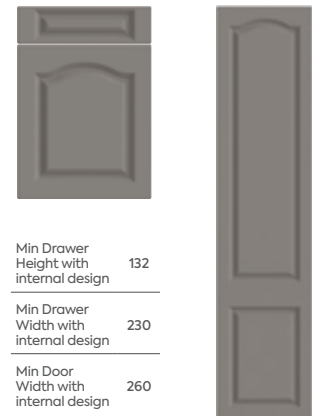

Min Drawer Height with internal design	132
Min Drawer Width with internal design	230
Min Door Width with internal design	260

### Carrick

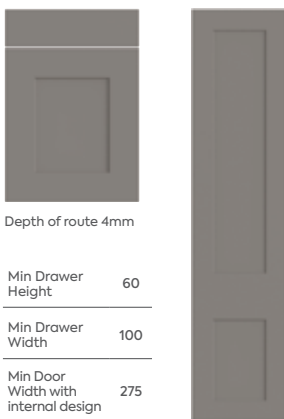

Depth of route 4mm

Min Drawer Height	60
Min Drawer Width	100
Min Door Width with internal design	275

### Chester

(Not available in High Gloss Colours)

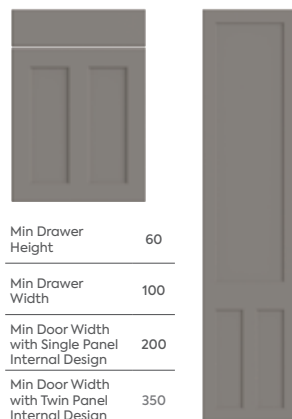

Min Drawer Height	60
Min Drawer Width	100
Min Door Width with Single Panel Internal Design	200
Min Door Width with Twin Panel Internal Design	350

### Elland

(Not available in High Gloss Colours)

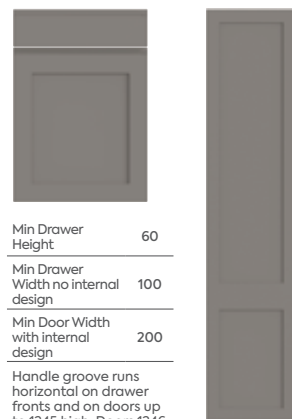

Min Drawer Height	60
Min Drawer Width no internal design	100
Min Door Width with internal design	200

Handle groove runs horizontal on drawer fronts and on doors up to 1245 high. Doors 1246 and above the handle groove runs vertical.

### Euroline

(Not available in High Gloss Colours)

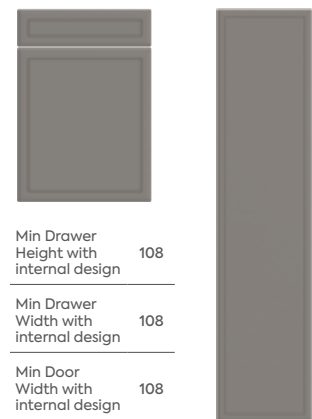

Min Drawer Height with internal design	108
Min Drawer Width with internal design	108
Min Door Width with internal design	108

### Helmsley

(Not available in High Gloss Colours)



Min Drawer Height	121
Min Drawer Width no internal design	121
Min Door Width with Internal Design	265

### Integra (Full Handle Option)

(Not available in High Gloss Colours)



Min Drawer Height	60
Min Drawer/Door Width	240

Handle groove on drawer fronts and doors up to 1699 high have a groove on the top. Doors 1700 high and above have a groove on the L/R side.

### Integra

(Not available in High Gloss Colours)



Min Drawer Height	60
Min Drawer/Door Width	240

Handle groove on drawer fronts and doors up to 1699 high have a 200mm long groove on the top. Doors 1700 high and above have a 900mm long groove on the L/R side.

### Knebworth (Stopped Handle Option)

(Not available in High Gloss Colours)

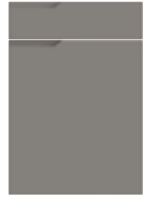

Left hand Door Right hand Door

Min Drawer Height	60
Min Drawer/Door Width	250

The Knebworth door style is available with a left or right hand stopped handle option as shown above. The handle groove is 200mm long.

### Knebworth

(Not available in High Gloss Colours)



Min Drawer Height	60
Min Drawer / Door Width	100

Handle groove runs horizontal on drawer fronts and on doors up to 1245 high. Doors 1246 and above the handle groove runs vertical.

### Lazio



Min Drawer Height	120
Min Drawer/Door Width	240

The Lazio design incorporates the handle. Specify the handle colour option when ordering. See page 135.

### Lincoln



Min Drawer Height	60
Min Drawer/Door Width	100

### Newport

(Not available in High Gloss Colours)

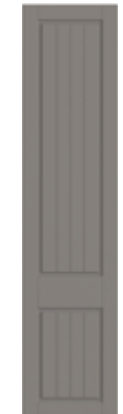

Min Drawer Height with internal design	100
Min Drawer Width with internal design	240

Min Door Width with internal design 240

### Oakham

(Not available in High Gloss Colours)



Min Drawer Height	60
Min Drawer Width	100

Min Door Width with Internal Design 155

### Palermo



Min Drawer Height with internal design	132
----------------------------------------	-----

Min Drawer Width with internal design	230
---------------------------------------	-----

Min Door Width with internal design 246

### Pisa



Min Drawer Height	60
-------------------	----

Min Drawer/Door Width 100

### Richmond



Min Drawer Height	60
-------------------	----

Min Drawer Width	100
------------------	-----

Min Door Width with internal design 210

# Bella

## Door Styles & Specifications

**NEW**  
New styles available

  
Made to Measure

  
7 day despatch

### Segreto

(Not available in High Gloss Colours)



Min Drawer Height	90
Min Drawer/Door Width	250

The Segreto design incorporates the handle. Specify the handle colour option when ordering. See page 135.



### Shaker

(Not available in High Gloss Colours)



Min Drawer Height	60
Min Drawer Width	100
Min Door Width with internal design	220



### Stratford

(Not available in High Gloss Colours)

**NEW**



Min Drawer Height	60
Min Drawer Width	100
Min Door Width with Single Panel Internal Design	185
Min Door Width with Multi Panel Internal Design	300

All doors greater than 1699 H will have single panel design



For detailed door panel configurations on this style please download the Technical Specification from MyBA or contact Customer Services.

### Surrey

(Not available in High Gloss Colours)

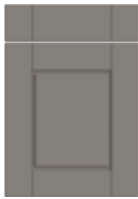

Min Drawer Height with internal design	100
Min Drawer Width with internal design	242
Min Door Width with internal design	242



### Tullymore

(Not available in High Gloss Colours)



Min Drawer Height with internal design	100
Min Drawer Width with internal design	100
Min Door Width with internal design	240

Doors from 100mm > 239mm width will have outer lines only and no centre panel.



### Venice



Min Drawer Height	60
Min Drawer/Door Width	100



### Warwick

(Not available in High Gloss Colours)



Min Drawer Height	100
Min Drawer Width	260
Min Door Width with internal design	260



### Westbury

(Not available in High Gloss Colours)



Min Drawer Height	60
Min Drawer Width	100
Min Door Width with internal design	245



### York



Min Drawer Height	140
Min Drawer Width	212
Min Door Width with internal design	246



# Bella

## Sloping Doors



Sloping doors are available in a wide variety of angles and shapes as shown on the sloping door order form.

\*Not available in High Gloss Colours



### MYBA SLOPING MYBA CALCULATOR

For a guide to measuring sloping ceilings and ordering doors log onto MyBA and click create a new order. Click doors and drawers and click Sloping Doors Calculator on the navigation menu.



Ashford Austin\* Buxton\* Cambridge Carrick Euroline\* Helmsley\* Lazio Lincoln Oakham\*

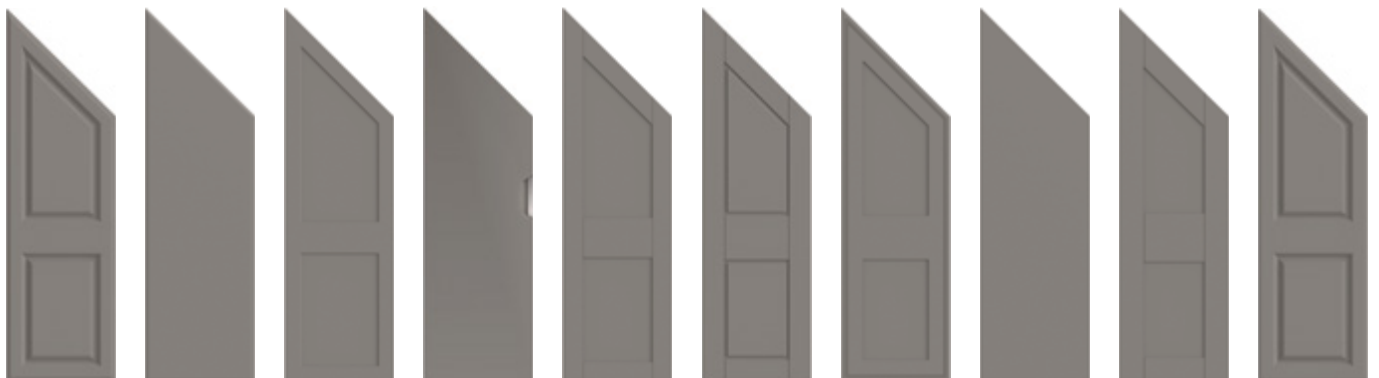

Palermo Pisa Richmond Segreto\* Shaker\* Surrey\* Tullymore\* Venice Warwick\* York

## Technical specification

- All doors and drawer fronts are 18mm thick.
- See pages 72-73 for details of colours and board matches.
- Available in any size within the specifications below.

### Drawer Fronts

- Minimum height 60mm, maximum height 282mm.
- Minimum width 100mm, maximum width 1200mm.
- Drawer Fronts are supplied with horizontal grain.

### Standard Doors

- Minimum height 283mm, maximum height 1699mm.
- Minimum width 100mm, maximum width 1200mm.  
(See pages 74-76 for internal design min. dimensions)

### Tall Doors

- Minimum height 1700mm, maximum height 2540mm.
- Minimum width 100mm, maximum width 1200mm.  
(See pages 74-76 for internal design min. dimensions)
- The maximum door size is 2540mm H x 1200mm W.
- Standard and tall doors are supplied with vertical grain in all colours.

Tall door designs with two panels will be supplied with the mid rail at 655mm from the bottom edge to the centre of the mid rail as standard unless otherwise specified.

### Doors for Corner Cabinets

Doors can be supplied with either the left or right side edge square. Available up to Max. 1699mm high.

### Horizontal Grain

Available in all woodgrain colour options up to Maximum 1200mm high. Horizontal grain is also supplied with Wine Rack Fronts and Canopies. PVC'd panels are manufactured as specified.

### High Gloss Colours

High gloss finishes are manufactured using a heavier gauge vinyl and definition can be less sharp on doors, panels and accessories with more detailed designs.

The following door styles are not available in gloss colours - Aldridge, Austin, Buxton, Chester, Elland, Euroline, Helmsley, Integra, Knebworth, Newport, Oakham, Segreto, Shaker, Stratford, Surrey, Tullymore, Warwick and Westbury.

Size H x W	Size H x W	Size H x W	Size H x W	Size H x W
115 x 396	355 x 796	715 x 796	1245 x 596	2155 x 296
115 x 496	355 x 896	715 x 996	1245 x 796	2155 x 396
115 x 596	355 x 996	715 x 1200	1245 x 996	2155 x 446
140 x 296	415 x 396	895 x 296	1245 x 1200	2155 x 496
140 x 396	415 x 446	895 x 396	1375 x 396	2155 x 596
140 x 446	415 x 496	895 x 446	1375 x 496	2155 x 796
140 x 496	415 x 596	895 x 496	1435 x 396	2155 x 996
140 x 596	450 x 596	895 x 596	1435 x 496	2155 x 1200
140 x 796	490 x 596	900 x 296	1435 x 796	2250 x 296
140 x 896	535 x 396	900 x 396	1435 x 996	2250 x 396
140 x 996	535 x 496	900 x 446	1435 x 1200	2250 x 446
175 x 396	570 x 296	900 x 496	1450 x 396	2250 x 496
175 x 496	570 x 396	900 x 596	1450 x 496	2250 x 596
175 x 596	570 x 446	900 x 796	1495 x 396	2400 x 296
175 x 796	570 x 496	900 x 996	1495 x 446	2400 x 396
175 x 996	570 x 596	900 x 1200	1495 x 496	2400 x 446
215 x 396	645 x 596	980 x 596	1495 x 596	2400 x 496
215 x 496	650 x 296	1055 x 396	1495 x 796	2400 x 596
215 x 596	650 x 396	1055 x 446	1495 x 996	2540 x 296
215 x 796	650 x 446	1055 x 496	1495 x 1200	2540 x 396
215 x 996	650 x 496	1055 x 596	1735 x 296	2540 x 446
283 x 496	650 x 596	1060 x 396	1735 x 396	2540 x 496
283 x 596	715 x 146	1060 x 446	1735 x 446	2540 x 596
283 x 796	715 x 296	1060 x 496	1735 x 496	2540 x 796
283 x 896	715 x 396	1060 x 596	1735 x 596	2540 x 996
283 x 996	715 x 446	1245 x 296	1735 x 796	2540 x 1200
355 x 496	715 x 496	1245 x 396	1735 x 996	
355 x 596	715 x 596	1245 x 496	1735 x 1200	

### STANDARD SIZES

Above shows standard size kitchen and bedroom doors and drawer fronts.

### MADE TO MEASURE DOOR SURCHARGES

For Pricing of Made to Measure Doors and Drawer Fronts, use next standard size up and add 10% to the price.

### DOOR STYLES SURCHARGES

The following styles have additional surcharges added to the relevant base door price. (Drawer front prices not affected).

Carrick, Oakham, Richmond, Shaker, Tullymore and Warwick styles +10%. Buxton, Cambridge, Chester, Helmsley

and Stratford doors have a 20% surcharge. Knebworth doors and drawer fronts have a 10% surcharge. Aldridge and Elland doors and drawer fronts have a 20% surcharge. (Aldridge drawer fronts above 159mm H).

### SLOPING DOORS SURCHARGES

Sloping Doors have an additional 50% surcharge added to the relevant base door price.

### FRAMES & FEATURE DOORS

For Frame, Glazing and Feature Doors see pages 80-81.

### HINGE HOLES

35mm diameter x 13mm depth.





### Open Frame Doors

All open frame doors are available in all door styles in any size. Prices as per door size + 25%.



**Drawer Frame**

Prices as per drawer size + 25%

Min height 175mm  
Max height 354mm  
Min width 296mm  
Max width 1200mm

*Not available in:*

- \* High Gloss Colours
- \* Integra, Knebworth, Inset, Lazio and Segreto styles

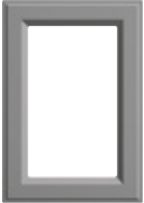

**Open Frame**

Open frames are available

Min height 283mm  
Max height 1699mm  
Min width 296mm  
Max width 650mm

**Aldridge Open Frames**

283 to 649mm - all open, no panels  
650 to 1494mm - top panel only open  
1495mm - all 3 panels open  
1496 to 1699mm - top panel only open  
1700 to 2540mm - 4 panels open

**Stratford Open Frames**

283 to 649mm - all open, no panels  
650 to 1494mm - top panel only open  
1495mm - all 3 panels open  
1496 to 1699mm - top panel only open  
1700 to 2540mm - 4 panels open

### Letterbox Frame Doors



Frame doors can be fitted with the slot to the top or bottom.

Prices as per door size + 25%. Available from

Min height 355mm - Max height 2540mm.  
Min width 296mm - Max width 1200mm.  
An internal design is supplied with Ashford, Euroline and Tullymore styles.

*Integrated handle door styles are not available*

#### Top Open Frame



#### Top & Bottom Open Frame



#### Full Open Frame

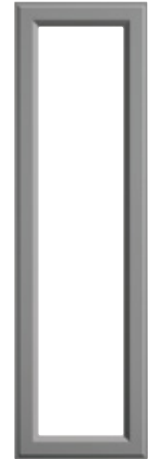

The above 3 options are available on doors: Min height 1700mm - Max height 2540mm. The top open and top & bottom open frames are available with any mid rail height. (655mm supplied unless other requested). Min width 296mm - Max width 650mm.

### Georgian Frame Doors

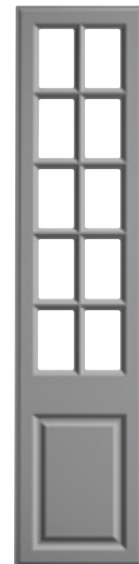

Mid rail height  
655mm only  
2155H x 396W  
2155H x 446W  
2155H x 496W



1495H x 396W  
1495H x 446W  
1495H x 496W



715H x 396W  
715H x 446W  
715H x 496W

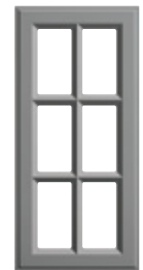

1055H x 396W  
1055H x 446W  
1055H x 496W

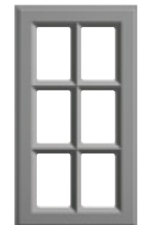

900H x 396W  
900H x 446W  
900H x 496W

*Not available in:*

- \* High Gloss Colours
- \* Aldridge, Austin, Integra, Knebworth, Inset, Lazio, Segreto and Stratford Styles

## Feature Frame Doors

Feature frame doors are available in any size. Prices as per door size + 25%. An internal design is supplied with Ashford, Euroline and Tullymore styles on wave, porthole and square hole frames.

### Wave Frame

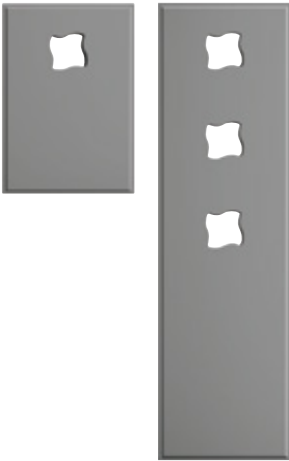

### Porthole Frame

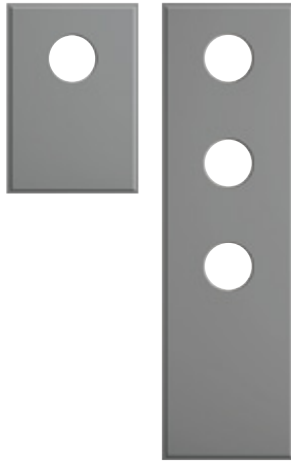

### Square Hole Frame

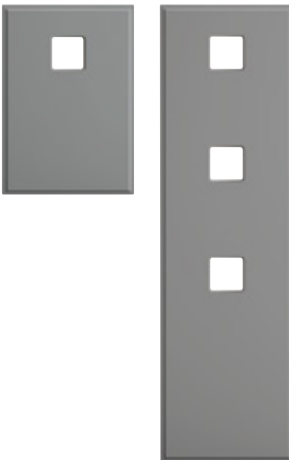

### Five Hole Frame

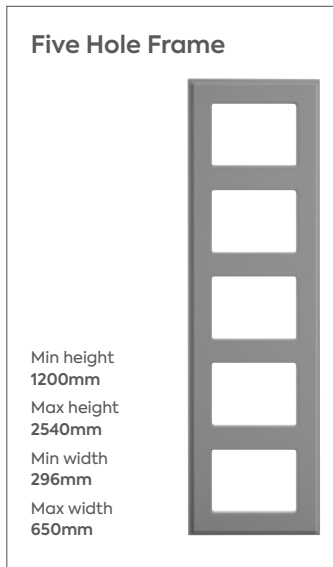

Small frames available from: Min height 355mm - Max height 1699mm.  
Large frames available from Min height 1700mm - Max height 2540mm.  
Min width 296mm - Max width 1200mm

*Integrated handle door styles are not available*

## Glass Fixing Options

We can supply frame doors in the following options:

1. All frame doors can be supplied rebated with clear acrylic glazing fitted.
2. All frame doors can be supplied without a rebate and instead are supplied with a bag of 10 clear plastic clips for fixing 4mm glazing. Supplied as standard if no alternative specified.
3. All frame doors can be supplied rebated and grooved and include rubber seal ready for glazing (Suitable for 4mm glass). Glazing sizes and radius will be specified on order acknowledgement.

### Frame with clear plastic clips

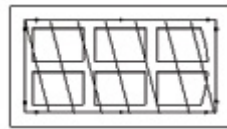

View from back of frame

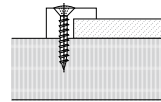

Side view

### Frame with rubber seal

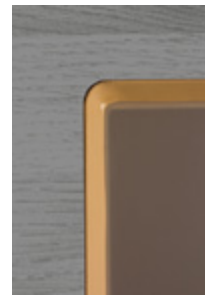

## Glazing (Clear)

We can supply glazed frame doors in clear acrylic.

To calculate the glazing prices, add the relevant percentage/price to the cost of the frame.

*Note: Glazing supplied is acrylic.*



# Bella

## Curved Doors and Components



Made to Measure



7 day despatch



### PLAIN DOORS

715 x 298 x 298 Wall/Base Door

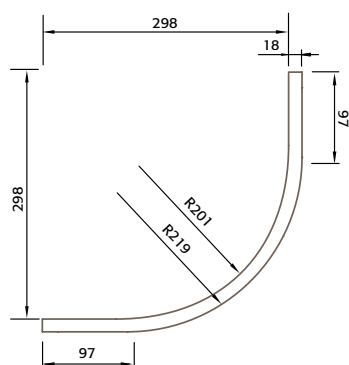

### CABINET

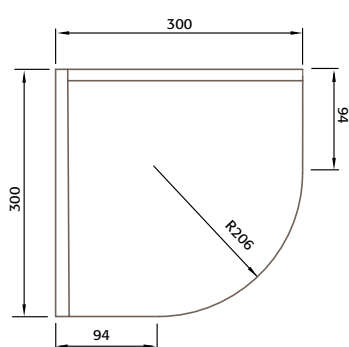

### BASE CABINET

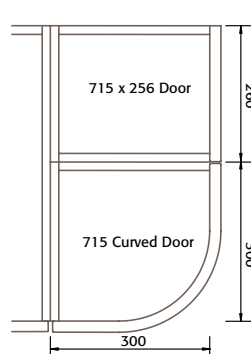

### WALL CABINET

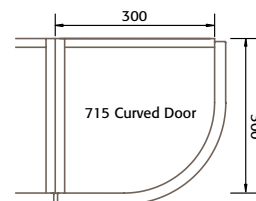

### CURVED MULTI-PURPOSE RAIL (CORNICHE)

Fit front edge flush with front of curved door

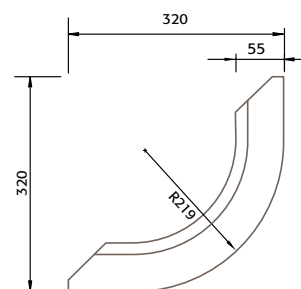

### 150 HIGH CURVED PLINTH (KITCHEN)

Fit front edge 50mm back from edge of carcass

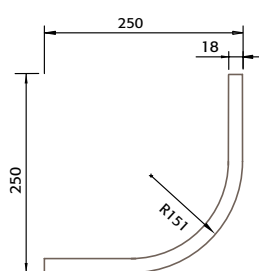

### BELLA CURVED DOOR CABINET

Vinyl wrapped components. Some colours do not have a matching back, see pages 72-73. 720mm x 300mm x 300mm (2 shelves). Code: ACDC7



Not available in Opengrain White.

Back colour on all curved doors is silver. For technical details on curved components see page 82.



#### Plain Curved Doors (Kitchen)

Wall/Base Door 715mm x 298mm x 298mm  
Code: **ACD7**  
Not available in *Opengrain White*.



#### Shaker Curved Doors

Wall/Base Door 715mm x 298mm x 298mm  
Code: **ASCD7**  
Not available in *High Gloss Colours* or *Opengrain White*.



#### Curved Plinth (Kitchen)

150mm H x 250mm x 250mm. Fit front edge 50mm back from edge of carcass. Code: **ACDP15**  
Not available in *Opengrain White*.



#### Curved Multi-Purpose Rail

320mm x 320mm x 36mm. For use as cornice and pelmet.  
Fit front edge flush with front of curved door.  
Code: **ACMPR**  
Not available in *Opengrain White*.

See page 84 for full accessory colour options available.



### CORNICE AND LIGHT PELMET



#### Classic Cornice

74mm High when fixed. 3050mm L  
Code: **ACLASCOR**

### MULTI-PURPOSE RAIL OPTIONS



#### Multi-Purpose Rail

55mm x 36mm x 3050mm L  
Code: **AMPR**



#### Curved Multi-Purpose Rail

320mm x 320mm x 36mm.  
For use as cornice and pelmet.  
Fits flush with door face.  
Code: **ACMPR**



#### Bullnose Cornice/Pelmet

48mm High when fixed. 3050mm L  
Code: **ABULCP**

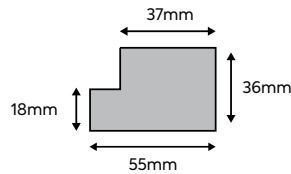

Can be used for various applications including cornice, pelmet, gable ends, pilasters and to box around a group of Cabinets.

## Panel & Top Options

### Square edge, profiled edge, T & G, and shaped panels and tops

- All panels/tops are available in 18mm and 25mm thick options. See page 72-73 for Back Colour on 18mm. The Back Colour on 25mm is white and FSC® certified. A 3mm edge profile is supplied on 25mm panels.
- 18mm and 25mm panels/tops are available in all colours except T&G panels which are not available in high gloss colours.
- Max size we can supply is 2540mm long x 1200mm deep.



### Wrap Around C-Panel

- All panels are 18mm thick and when constructed will have no visible raw edges.
- All panels supplied with a doweled Butt joint for easy assembly.
- Handle-less Rail End Panels - use **C-Panel** with depth of 45mm.
- All panels are vertical grain unless otherwise specified.

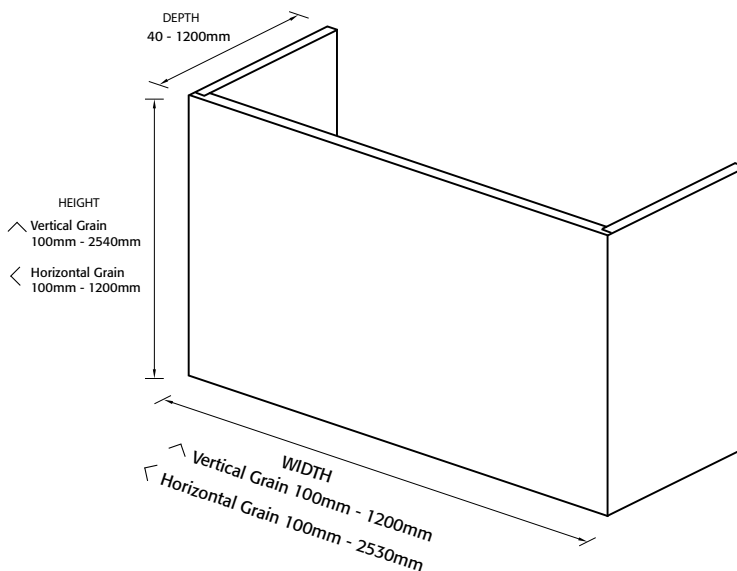

#### Wrap Around C-Panel

Price per m<sup>2</sup> (3 panels)  
Code: **APWABC**

### Wrap Around G-Panel

- All panels are 18mm thick and when constructed will have no visible raw edges.
- All panels supplied with a doweled Butt joint for easy assembly.
- All panels are vertical grain unless otherwise specified.
- For widths 400mm or less returns should be 100mm.

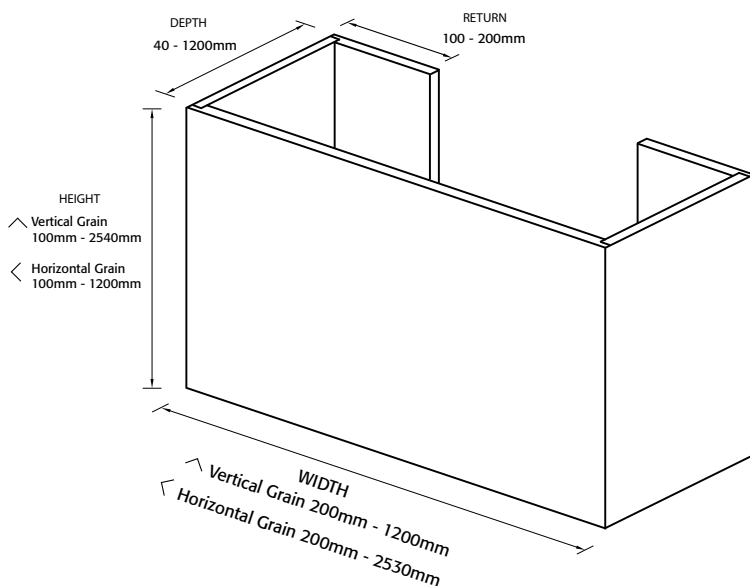

#### Wrap Around G-Panel

Price per m<sup>2</sup> (5 panels)  
Code: **APWABG**



### Over Mantle Options

Over Mantle Kits are available for 1000mm, 1100mm & 1200mm apertures. Suitable to fit up to 330mm deep wall units. If you require a different size Mantle refer to the parts list and adjust the sizes accordingly - then order all parts separately.



#### Over Mantle Kits

1000mm Shelf Mantle Kit Code: **ABSFM10**  
1100mm Shelf Mantle Kit Code: **ABSFM11**  
1200mm Shelf Mantle Kit Code: **ABSFM12**

#### Shelf for Non Standard Mantle (excludes corbels)

Available from 1000mm > 2540mm L  
Code: **ANSM**



#### Arched Facia for Non Standard Mantle

Code: **AAFM**



#### Pair of Mantle Corbels

195mm H 115mm W 85mm D  
Code: **APMC**

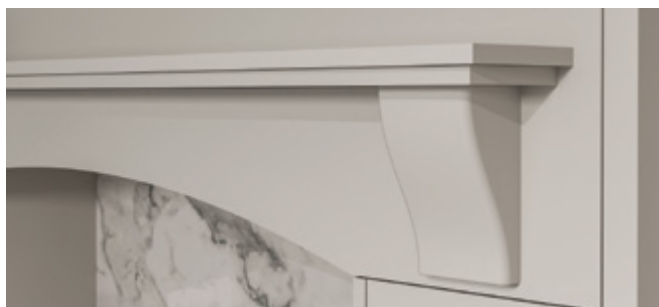

### Pilaster Options



#### Classic Pilasters

100mm W x 18mm D x 885mm L. Code: **ACPIL 8**  
 100mm W x 18mm D x 940mm L. Code: **ACPIL 9**

### Canopy Options



#### Plain Canopy

450mm H x 1100mm W (Can be reduced to 720mm W).  
 Base board supplied. Code: **APCANOPY**

### Pelmet Options



#### Arched Pelmet

Available in any length from 360mm > 2540mm  
 360mm to 1200mm L = 120mm H,  
 1201mm to 2540mm L = 200mm H  
 Code: **AARP**

### Scroll Panel Options



#### Scroll End Panel (excludes shelf)

1050mm H x 350mm D (720mm H Cabinet)  
 1230mm H x 350mm D (900mm H Cabinet)  
 Plain Panels (Handed)  
 720 LH Code: **APSE7L**  
 720 RH Code: **APSE7R**  
 900 LH Code: **APSE9L**  
 900 RH Code: **APSE9R**

T&G Panels (Handed)  
 720 LH Code: **ATGSE7L**  
 720 RH Code: **ATGSE7R**  
 900 LH Code: **ATGSE9L**  
 900 RH Code: **ATGSE9R**  
*Not available in High Gloss Colours*

## Wine Rack Options



Plain Wine Rack Front  
 715mm x 150mm 4 bottle Code: APWRF1  
 715mm x 296mm 8 bottle Code: APWRF2  
 715mm x 496mm 16 bottle Code: APWRF4



Heat Deflectors  
 For use with a 600mm Single Oven  
 (fitted into a tall appliance tower cabinet)  
 Code: APHD7

For use with a 900mm Double Oven  
 (fitted into a tall appliance tower cabinet)  
 Code: APHD9

For use with a 600mm Single Oven  
 (fitted into a Built-Under Oven cabinet)  
 Code: APHD6

## General Accessories



Wall End Shelf Unit  
 Unassembled  
 720mm H x 300mm W x 300mm D  
 Code: AWALL720  
 900mm H x 300mm W x 300mm D  
 Code: AWALL900



Base End Shelf Unit  
 Unassembled  
 720mm H x 300mm W x 570mm D  
 (Right hand shown)  
 Code: ABASEL (Left hand)  
 Code: ABASER (Right hand)



Pre glued Edging Tape  
 22mm X 50M Code: AEDGING  
 High Gloss Colours have a matt finish except  
 for High Gloss White and High Gloss Cashmere.  
 Not available in Matt Taupe or Matt Pebble.



Self Adhesive Vinyl  
 Peel & Stick Vinyl 620mm W  
 Price per linear metre.  
 Code: ASAF - 620mm W  
 Code: A25SAF - 25M Roll



Vinyl  
 Non Adhesive Vinyl.  
 1400mm W  
 Price per linear metre.  
 Code: AFOIL1400

### General Accessories



**PVC'd Plinth**

Can be supplied any height between 100mm and 200mm.  
2540mm L. Code: **APLINTHPVCSQ**



**Aluminium Plinth**

150mm H x 3M L. Pack of 12 clips included. Code: **AAP**



**PVC'd Profiled Plinth**

Can be supplied any height between 100mm and 200mm.  
Profile matches outer edge of door style.  
2540mm L. Code: **APLINTHPVCP**



**Dentil Rail (excludes cornice & panel)**

2540mm L x 60mm H. Code: **ADENR**

## Corner Posts

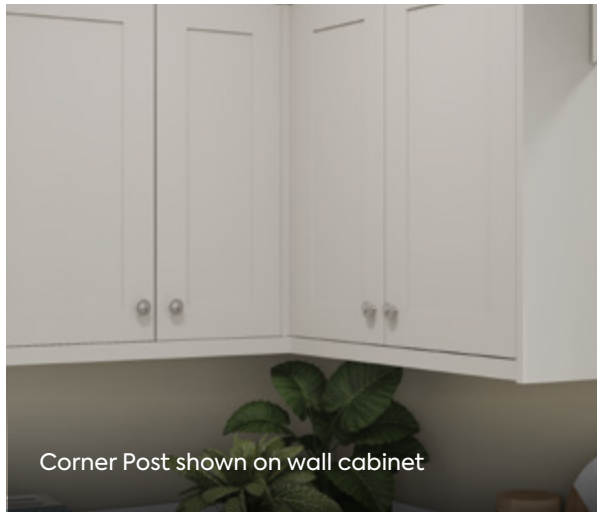

Corner Post shown on wall cabinet



Corner Post shown on base cabinet



### Internal Corner Post\*

720H x 80 x 80. L-Shape, 2 piece. Code: **ACORNER80**

900H x 80 x 80. L-shape, 2 piece. Code: **ACORNER980**

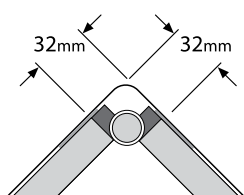

### Hinged Corner Post

715mm. Complete with all fixings.

Note: Reduce door widths as illustration. Where door edges fix to post - order square edge.

Stainless steel Code: **AHCPSS**  
Satin chrome Code: **AHCPSC**



### Corner Post

720mm L X 30mm x 30mm.  
Code: **ACORNER30**

720mm L X 40mm x 40mm.  
Code: **ACORNER40**

\*See page 120 & 121 for corner planning details.  
See page 84 for full accessory colour options available.

# Made to Measure Doors and Matching Accessories





# Jayline

A stunning 'J' Profile Handleless door, available in 11 stunning on-trend Supermatt or Supergloss colours.

- 19mm MDF 'J' Profile door
- Choose from 11 on-trend colours
- Available in standard and non standard sized kitchen doors, drawer fronts and matching accessories.
- Despatched within 7 days\*
- The Jayline range carry a 6 year warranty.



Cert No. PC0051

FIRA Gold Certification is the ultimate mark of product excellence within the furniture industry and provides a solid reassurance that a product meets all necessary standards.

A selection of Jayline doors have been tested by FIRA International and achieved FIRA Gold Certification Tests : **BS 6222-3**.

\*Please check communication updates on MyBA for live updates on lead times as they may fluctuate slightly during busy periods.

### RANGE SPECIFICATION

19mm MDF J Profile Handleless Door.

Wrapped door with a continuous laminate on top edge and face. Jayline uses a PUR adhesive system giving the highest heat and moisture resistance available.

Note: When ordering Jayline doors with hinge-holes, specify handing and groove (handle) position.

E.g. drill 98T 98B LH handle top.

### CERTIFICATION

Products marked (F) are FSC® certified. The Jayline range has attained the FIRA gold award.

- Min height 140mm, max height 1245mm.
- Min width 146mm, max width 1200mm.

Surcharges apply. See price list for details.

Any made to measure size will be produced from a standard bar (using the next size up) and cut down to height & re-edged. Therefore the use of edging will apply to all made to measure sizes.

### BOARD MATCHES

Supergloss/Supermatt

The manufacturers board references listed below are for guidance only. Check colour samples from your board supplier for your own approval.

#### WHITE

Egger: <b>W980</b>	Kronospan: <b>K101</b>	Pfleiderer: <b>W300</b>	Finsa White: <b>020</b>
--------------------	------------------------	-------------------------	-------------------------

#### LIGHT GREY

Egger: <b>U708</b>	Kronospan: <b>0112</b>	Finsa: <b>U12 Natural Grey</b>	Pfleiderer: <b>U1188</b>
--------------------	------------------------	--------------------------------	--------------------------

#### DUST GREY

Egger: <b>U732</b>	Pfleiderer: <b>U12150</b>	Kronospan: <b>0171 Slate Grey</b>
--------------------	---------------------------	-----------------------------------

#### GRAPHITE

Egger: <b>U961</b>	Pfleiderer: <b>U17010 (U1980) Terra Brown</b>	Kronospan: <b>0164 Anthracite</b>
--------------------	-----------------------------------------------	-----------------------------------

#### INDIGO BLUE

Egger: <b>U599</b>
--------------------

#### CASHMERE

Egger: <b>U702</b>	Kronospan: <b>5981</b>	Pfleiderer: <b>U1168</b>	Finsa: <b>15R</b>
--------------------	------------------------	--------------------------	-------------------

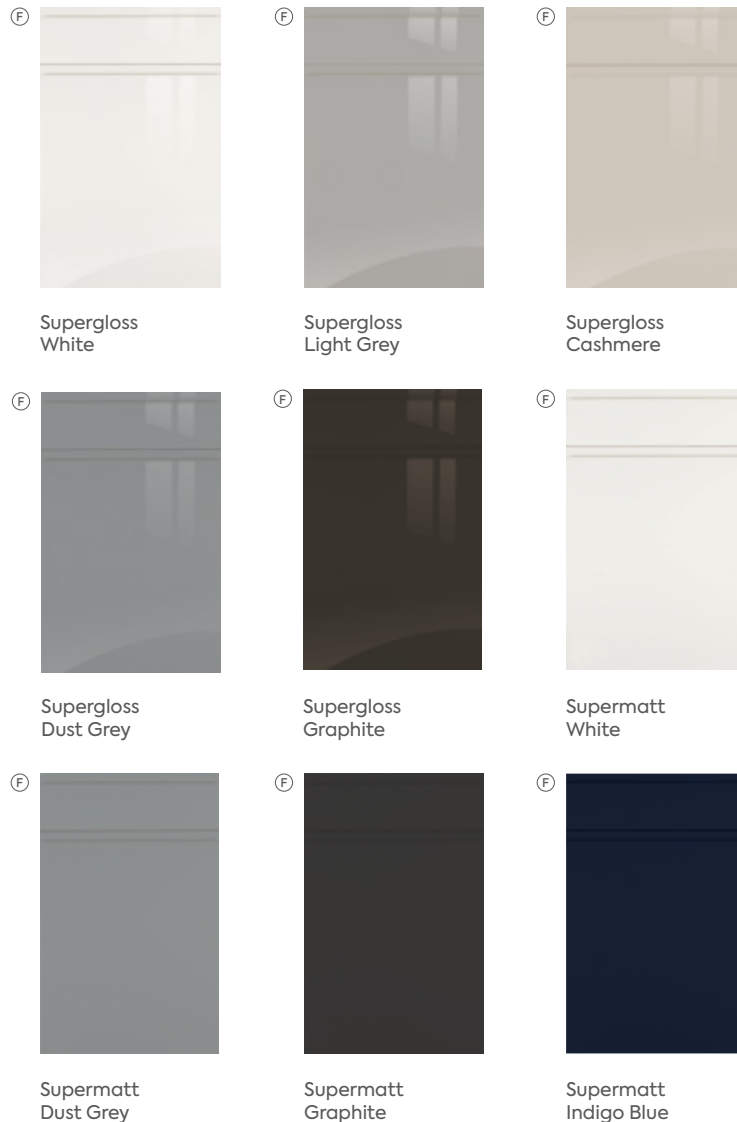

Supermatt Light Grey

Supermatt Cashmere

Supermatt Dust Grey

Supermatt Graphite

Supermatt Indigo Blue



# Jayline

## Range Accessories



**Breakfast Bar Panel**  
2100H x 900W (Made to Order)

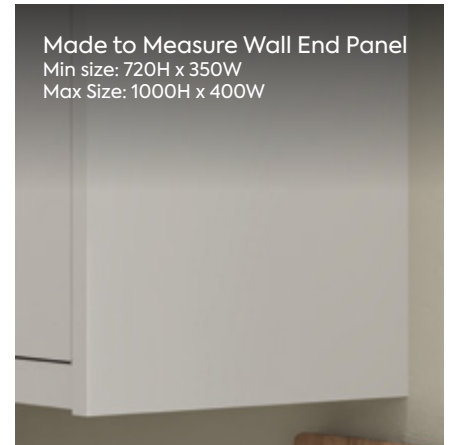

**Made to Measure Wall End Panel**  
Min size: 720H x 350W  
Max Size: 1000H x 400W



**Pre Glued Edging Tape**  
22T x 50M (Matt & Gloss Finish Available)



**Multi-Purpose Rail**  
55W x 36T x 3050L

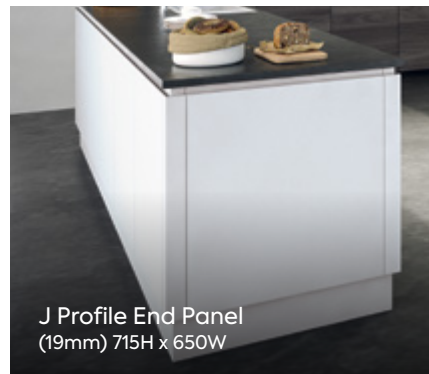

**J Profile End Panel**  
(19mm) 715H x 650W



**Square End Panel (18mm)**  
800H x 350W  
900H x 600W  
2150H x 600W

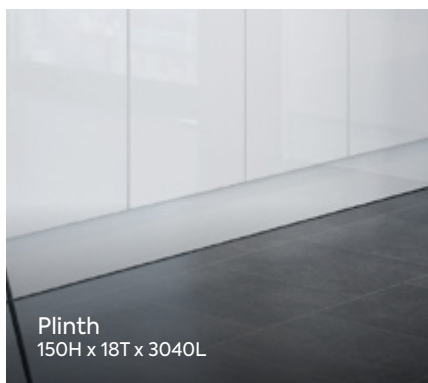

**Plinth**  
150H x 18T x 3040L

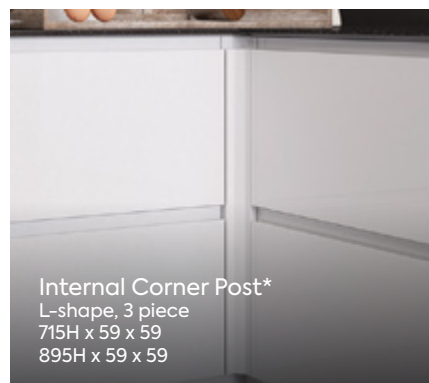

**Internal Corner Post\***  
L-shape, 3 piece  
715H x 59 x 59  
895H x 59 x 59



**External Corner Post**  
900H x 59 x 59

\* See page 120 & 121 for corner planning details.

# Made to Measure Doors and Matching Accessories





# Firbeck

A stunning collection of kitchen doors and drawer fronts. This slab door has a matching edge and is a superb choice for modern kitchen styling.

- 18mm MDF slab door
- Choose from 11 on-trend colours
- Available in standard and non standard sized kitchen doors, drawer fronts and matching accessories.
- Despatched within 7 days\*
- The Firbeck range carry a 6 year warranty.



Cert No. PC0051

FIRA Gold Certification is the ultimate mark of product excellence within the furniture industry and provides a solid reassurance that a product meets all necessary standards.

A selection of Firbeck doors have been tested by FIRA International and achieved FIRA Gold Certification Tests : **BS 6222-3**.

\*Please check communication updates on MyBA for live updates on lead times as they may fluctuate slightly during busy periods.

### RANGE SPECIFICATION

18mm MDF slab door with matching edging. Laminated supergloss / supermatt surface with a matching melamine colour reverse. Laminated and edged with a PUR adhesive system giving the highest heat and moisture resistance available.

### CERTIFICATION

Products marked (F) are FSC® certified. The Firbeck range has attained the FIRA gold award

### BOARD MATCHES

Supergloss/Supermatt

The manufacturers board references listed below are for guidance only. Check colour samples from your board supplier for your own approval.

#### WHITE

Egger: **W1000**

#### INDIGO BLUE

Egger: **U599**

#### LIGHT GREY

Egger: **U708**

Kronospan: **0112**

Finsa: **U12 Natural Grey**

Pfleiderer: **U1188**

#### CASHMERE

Egger: **U702**

Kronospan: **5981**

Pfleiderer: **U1168**

Finsa: **15R**

#### DUST GREY

Egger: **U732**

Pfleiderer: **U12150**

Kronospan: **0171 Slate Grey**

Finsa: **Gris Tormenta 09F**

#### GRAPHITE

Egger: **U961**

Pfleiderer: **U17010 (U1980) Terra Brown**

Kronospan: **0164 Anthracite**

- Min height 110mm, max height 1245mm.
- Min width 146mm, max width 1200mm.



Supergloss White



Supergloss Light Grey



Supergloss Cashmere



Supergloss Dust Grey

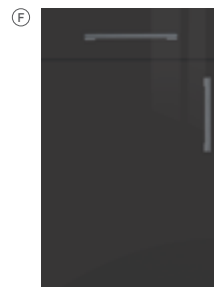

Supergloss Graphite

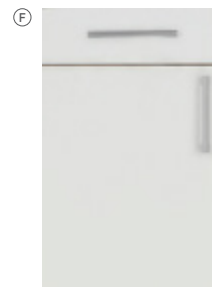

Supermatt White

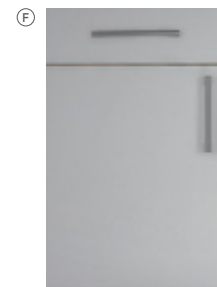

Supermatt Light Grey



Supermatt Cashmere



Supermatt Dust Grey



Supermatt Graphite



Supermatt Indigo Blue

# Firbeck

## Range Accessories



Breakfast Bar Panel  
2100H x 900W (Made to Order)



Made to Measure Wall End Panel  
Min size: 720H x 350W  
Max Size: 1000H x 400W



Plinth  
150H x 18T x 3040L



Multi-Purpose Rail  
55W x 36T x 3050L

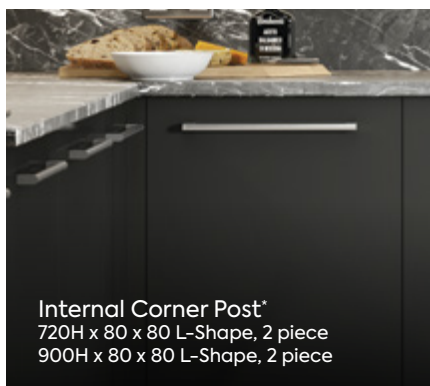

Internal Corner Post\*  
720H x 80 x 80 L-Shape, 2 piece  
900H x 80 x 80 L-Shape, 2 piece



Plain End Panel (18mm)  
800H x 350W  
900H x 600W  
2150H x 600W



Pre Glued Edging Tape  
22T x 50M (Matt & Gloss Finish Available)

\* See page 120 & 121 for corner planning details.

# Made to Measure Doors and Matching Accessories





# Wilton

A stunning 5 piece door available in both standard and non-standard sized kitchen doors and drawer fronts.

- 22mm 5 piece door construction
- Choose from 9 oakgrain colours
- Available in standard and non standard sized kitchen doors, drawer fronts and matching accessories.
- Despatched within 7 days\*
- The Wilton range carry a 6 year warranty.



Cert No. PC0051

FIRA Gold Certification is the ultimate mark of product excellence within the furniture industry and provides a solid reassurance that a product meets all necessary standards.

A selection of Wilton doors have been tested by FIRA International and achieved FIRA Gold Certification Tests : **BS 6222-3**.

\*Please check communication updates on MyBA for live updates on lead times as they may fluctuate slightly during busy periods.

### RANGE SPECIFICATION

5 piece door construction.  
The frames are 120mm W x 22mm MDF.  
Panels are 6mm. Drawer fronts are 1 piece 22mm. Doors and drawer have a 2mm chamfered edge. 715 x 146 door is a 1 piece. All other sizes are 5 piece. Drawer fronts up to 282 have horizontal grain.

### CERTIFICATION

Products marked (F) are FSC® certified.  
Products marked (P) are PEFC certified.  
The Wilton range has attained the FIRA gold award.

Drawer fronts are a 1 piece construction.

- Min height 110mm, max height 282mm.
- Min width 146mm, max width 1200mm.

Doors/Frames are a 5 piece construction.

- Min height 283mm, max height 1245mm.
- Min width 270mm, max width 1200mm.

Surcharges apply. See price list for details.

### BOARD MATCHES

Oakgrain

The manufacturers board references listed below are for guidance only. Check colour samples from your board supplier for your own approval.

#### OAKGRAIN WHITE

Egger: W1200	Kronospan: 101
--------------	----------------

#### OAKGRAIN MUSSEL

Kronospan: 5982	Finsa: Gris Porrino 194
-----------------	-------------------------

#### OAKGRAIN CREAM

Egger: U104	Kronospan: U514	Finsa: Ivory Bama 65B
-------------	-----------------	-----------------------

#### OAKGRAIN GREY

Egger: U708	Pfleiderer: U1188
-------------	-------------------

#### OAKGRAIN DAKKAR

Egger: U717	Kronospan: 5984
-------------	-----------------

#### OAKGRAIN CASHMERE

Egger: U702	Kronospan: 5981	Pfleiderer: U1168	Finsa: Gris Coco 15R
-------------	-----------------	-------------------	----------------------

#### OAKGRAIN DUST GREY

Egger: U732	Kronospan: 0171
-------------	-----------------

#### OAKGRAIN GRAPHITE

Egger: U961
-------------

#### OAKGRAIN AZURE BLUE

Egger: U504
-------------

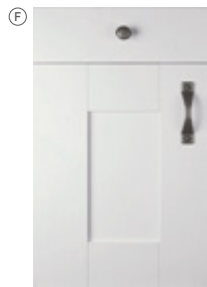

Oakgrain White



Oakgrain Cream



Oakgrain Grey

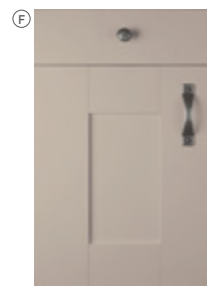

Oakgrain Cashmere



Oakgrain Graphite

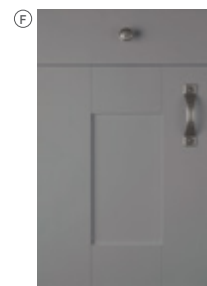

Oakgrain Dust Grey



Oakgrain Azure Blue



Oakgrain Dakkar



Oakgrain Mussel



# Wilton

## Range Accessories

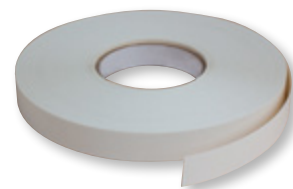

**Pre Glued Edging Tape**  
22T x 50M  
(Not available in Oakgrain Azure Blue)

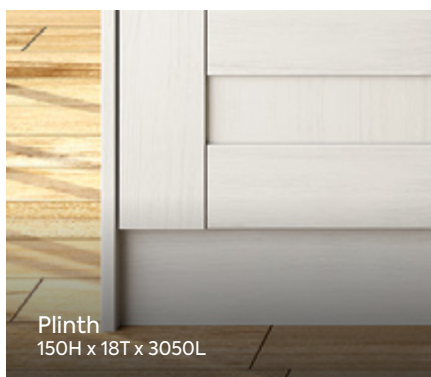

**Plinth**  
150H x 18T x 3050L

ⓔ



**Classic Cornice**  
3050L

ⓔ



**Multi-Purpose Rail**  
55W x 36T x 3050L

ⓔ

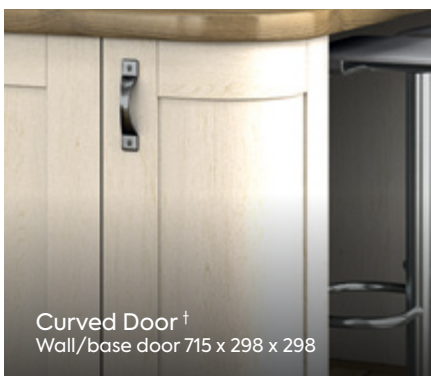

**Curved Door †**  
Wall/base door 715 x 298 x 298



**Curved Multi-Purpose Rail †**  
320 x 320 x 36T



**Curved Plinth †**  
150H x 300W x 560D



**Internal Corner Post\*\***  
720H x 80 x 80 L-Shape, 2 piece  
900H x 80 x 80 L-Shape, 2 piece

ⓔ



**T&G\*/Plain End Panels (18mm)**  
T&G 900 x 360  
T&G 900 x 650  
T&G 2400 x 650  
Plain 900 x 360  
Plain 900 x 650  
Plain 2400 x 650

ⓔ All colours except Oakgrain Dakkar, Oakgrain Graphite and Oakgrain Azure Blue.

\* Not available in Oakgrain White. \*\* See page 120 & 121 for corner planning details.  
† While stocks last. Please check with customer services before ordering.

# Made to Measure Doors and Matching Accessories





# Zurfiz

This stunning made to measure collection of ultra modern doors are available in 26 colour options - a mix of ultragloss solid colours, stone and metal effects, woodgrains and metallics along with supermatts and all rounded off by a brushed metal.

To add to the choice and flexibility of the range the doors are also offered with 3 edge options, matching edge, plywood effect and a stunning glass effect 3D edge producing a deceptively real glazed appearance.

- Available in kitchen, bedroom and bathroom made to measure sizes.
- 18mm MDF & MFC finishes in Acrylic, Melamine, PET and PVC materials with stunning gloss and matt levels.
- Edging applied using PUR (Poly Urethane Reactive) glue with a much higher heat and moisture resistance than normal hot melt glues.
- A selection of Zurfiz doors are FSC® or PEFC certified and have attained the FIRA gold award.
- The Zurfiz range carries a 6 year warranty.
- Manufactured and despatched within 7 working days.



Cert No. PC0051

FIRA Gold Certification is the ultimate mark of product excellence within the furniture industry and provides a solid reassurance that a product meets all necessary standards.

A selection of Zurfiz doors have been tested by FIRA International and achieved FIRA Gold Certification Tests : BS 6222-3.

# Zurfiz

## Colour Options\*



The manufacturers board references listed below are for guidance only. Check colour samples from your board supplier for your own approval. As an alternative to melamine boards we can supply you with matching panels.

### Zurfiz Ultragloss

					
<p><b>Glacier White</b></p> <p>Base Material: <b>MDF</b>            Back Colour: <b>Matching</b>            Egger: <b>W1300</b></p>	<p><b>White</b></p> <p>Base Material: <b>MDF</b>            Back Colour: <b>Matching</b>            Egger: <b>W980</b>            Kronospan: <b>K101</b>            Pfeleiderer: <b>W300</b>            Finsa: <b>White 020</b></p>	<p><b>Cream</b></p> <p>Base Material: <b>MDF</b>            Back Colour: <b>Matching</b>            Egger: <b>U104</b>            Kronospan: <b>U514</b>            Pfeleiderer: <b>U1303</b>            Finsa: <b>Ivory-Bama 65B</b></p>	<p><b>Cashmere</b></p> <p>Base Material: <b>MDF</b>            Back Colour: <b>Matching</b>            Egger: <b>U702</b>            Kronospan: <b>5981</b>            Pfeleiderer: <b>U1168</b>            Finsa: <b>15R</b></p>	<p><b>Light Grey</b></p> <p>Base Material: <b>MDF</b>            Back Colour: <b>Matching</b>            Egger: <b>U708</b>            Pfeleiderer: <b>U1188</b></p>	<p><b>Stone Grey</b></p> <p>Base Material: <b>MDF</b>            Back Colour: <b>Silver</b>            Order matching panels, see page 111</p>
					
<p><b>Baltic Blue</b></p> <p>Base Material: <b>MDF</b>            Back Colour: <b>Light Grey</b>            Order matching panels, see page 111</p>	<p><b>Black</b></p> <p>Base Material: <b>MDF</b>            Back Colour: <b>Matching</b>            Egger: <b>U999</b>            Kronospan: <b>U190</b>            Pfeleiderer: <b>U1200</b>            Finsa: <b>Negro 231</b></p>	<p><b>Metallic Champagne</b></p> <p>Base Material: <b>MDF</b>            Back Colour: <b>Silver</b>            Order matching panels, see page 111</p>	<p><b>Metallic Blue</b></p> <p>Base Material: <b>MDF</b>            Back Colour: <b>Silver</b>            Order matching panels, see page 111</p>	<p><b>Metallic Anthracite</b></p> <p>Base Material: <b>MDF</b>            Back Colour: <b>Silver</b>            Egger: <b>U961</b></p>	<p><b>Limestone</b></p> <p>Base Material: <b>MDF</b>            Back Colour: <b>Matching</b>            Alvic: <b>Melange 1</b></p>
		<h3>CERTIFICATIONS</h3> <p>Colours marked (P) are PEFC Certified.            Colours marked (F) are FSC Certified.</p> <p>Note:</p> <ul style="list-style-type: none"> <li>• All Serica matt colours have Serica foil both sides.</li> <li>• All Supermatt colours have Supermatt foil both sides.</li> <li>• Japanese Pear - We cannot guarantee matching grain directions on replacement orders only. There can be slight variances in batches over time.</li> <li>• For woodgrain/patterned finishes: Due to variance in pattern repeat and production processes we cannot guarantee a matched pattern/book match on door runs/combinations or drawer packs.</li> <li>• ONLY Metallic Blue and Metallic Champagne are directional as marked by arrows on the protective film. The arrows must point upwards when fitted. Please ensure when ordering doors with inset or inter handles or with drilling that you specify left or right hand doors.</li> </ul>			
<p><b>Copperleaf</b></p> <p>Base Material: <b>MDF</b>            Back Colour: <b>Matching</b>            Alvic: <b>Cuzco Oro</b></p>	<p><b>Japanese Pear</b></p> <p>Base Material: <b>MDF</b>            Back Colour: <b>Silver</b>            Order matching panels, see page 111</p>				

\*Please note printed colour swatches are for reference only and final purchasing decisions should be made after viewing physical swatch – (see page 143).

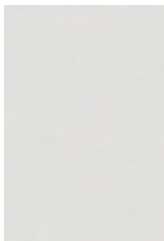
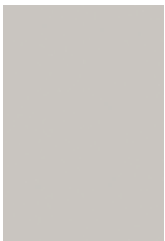
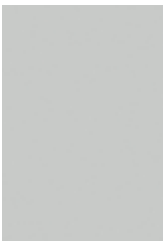
## Zurfiz Supermatt

				
<p><b>White</b></p> <hr/> <p>Base Material: <b>MDF</b> Back Colour: <b>Matching</b> Egger: <b>W1000</b></p>	<p><b>Cashmere</b></p> <hr/> <p>Base Material: <b>MDF</b> Back Colour: <b>Matching</b> Egger: <b>U702</b> Kronospan: <b>5981</b> Pfleiderer: <b>U1168</b> Finsa: <b>15R</b></p>	<p><b>Light Grey</b></p> <hr/> <p>Base Material: <b>MDF</b> Back Colour: <b>Matching</b> Egger: <b>U708</b> Pfleiderer: <b>U1188</b></p>	<p><b>Dust Grey</b></p> <hr/> <p>Base Material: <b>MDF</b> Back Colour: <b>Matching</b> Egger: <b>U732</b></p>	<p><b>Graphite</b></p> <hr/> <p>Base Material: <b>MDF</b> Back Colour: <b>Matching</b> Egger: <b>U961</b></p>

## Zurfiz Serica Matt

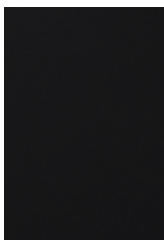
					
<p><b>Pebble</b></p> <hr/> <p>Base Material: <b>MDF</b> Back Colour: <b>Matching</b> Egger: <b>U201</b></p>	<p><b>Taupe</b></p> <hr/> <p>Base Material: <b>MDF</b> Back Colour: <b>Matching</b></p>	<p><b>Kombu Green</b></p> <hr/> <p>Base Material: <b>MDF</b> Back Colour: <b>Matching</b></p>	<p><b>Plum</b></p> <hr/> <p>Base Material: <b>MDF</b> Back Colour: <b>Matching</b></p>	<p><b>Indigo Blue</b></p> <hr/> <p>Base Material: <b>MDF</b> Back Colour: <b>Matching</b></p>	<p><b>Black</b></p> <hr/> <p>Base Material: <b>MDF</b> Back Colour: <b>Matching</b> Egger: <b>U999</b></p>

## Zurfiz Special

<p><b>Stainless Steel</b></p> <hr/> <p>Base Material: <b>MDF</b> Back Colour: <b>Silver</b> Order matching panels, see page 111.</p>

## Zurfiz Edge Options



Matching

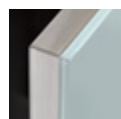

Glass Effect



Plywood Effect

The Zurfiz range is available in 3 edge options:

Note:

- Glass effect only available in Ultragloss colours (except Ultragloss Stone Grey)

### BOARD MANUFACTURERS DISTRIBUTOR DETAILS:

[www.eggerstockists.com/product-type-search.php](http://www.eggerstockists.com/product-type-search.php)

[www.pfleiderer.co.uk/distributors](http://www.pfleiderer.co.uk/distributors)

[www.finsa.com](http://www.finsa.com)

(click tools, click distributors, click Superpan Tech)

[www.panelco.com](http://www.panelco.com) (UK Distributor for Alvic Board)

Contact Kronospan on Tel: **01691 773361**

### Technical specification

- All doors and drawer fronts are 18mm thick.
- Available in any size within the specifications below.
- Minimum height 100mm, maximum height 2540mm.
- Minimum width 100mm, maximum width 1200mm.
- Woodgrain direction on drawer fronts is horizontal, 100mm – 282mm High.
- Woodgrain direction on doors is vertical, 283mm – 2540mm High.
- Horizontal woodgrain can be supplied on doors up to 1200mm High, please specify when ordering.
- See page 106 & 107 for details of colours and board matches.

Size H x W	Size H x W	Size H x W	Size H x W	Size H x W
115 x 396	355 x 796	715 x 796	1245 x 596	2155 x 296
115 x 496	355 x 896	715 x 996	1245 x 796	2155 x 396
115 x 596	355 x 996	715 x 1200	1245 x 996	2155 x 446
140 x 296	415 x 396	895 x 296	1245 x 1200	2155 x 496
140 x 396	415 x 446	895 x 396	1375 x 396	2155 x 596
140 x 446	415 x 496	895 x 446	1375 x 496	2155 x 796
140 x 496	415 x 596	895 x 496	1435 x 396	2155 x 996
140 x 596	450 x 596	895 x 596	1435 x 496	2155 x 1200
140 x 796	490 x 596	900 x 296	1435 x 796	2250 x 296
140 x 896	535 x 396	900 x 396	1435 x 996	2250 x 396
140 x 996	535 x 496	900 x 446	1435 x 1200	2250 x 446
175 x 396	570 x 296	900 x 496	1450 x 396	2250 x 496
175 x 496	570 x 396	900 x 596	1450 x 496	2250 x 596
175 x 596	570 x 446	900 x 796	1495 x 396	2400 x 296
175 x 796	570 x 496	900 x 996	1495 x 446	2400 x 396
175 x 996	570 x 596	900 x 1200	1495 x 496	2400 x 446
215 x 396	645 x 596	980 x 596	1495 x 596	2400 x 496
215 x 496	650 x 296	1055 x 396	1495 x 796	2400 x 596
215 x 596	650 x 396	1055 x 446	1495 x 996	2540 x 296
215 x 796	650 x 446	1055 x 496	1495 x 1200	2540 x 396
215 x 996	650 x 496	1055 x 596	1735 x 296	2540 x 446
283 x 496	650 x 596	1060 x 396	1735 x 396	2540 x 496
283 x 596	715 x 146	1060 x 446	1735 x 446	2540 x 596
283 x 796	715 x 296	1060 x 496	1735 x 496	2540 x 796
283 x 896	715 x 396	1060 x 596	1735 x 596	2540 x 996
283 x 996	715 x 446	1245 x 296	1735 x 796	2540 x 1200
355 x 496	715 x 496	1245 x 396	1735 x 996	
355 x 596	715 x 596	1245 x 496	1735 x 1200	

### STANDARD SIZES

Above shows standard size kitchen and bedroom doors and drawer fronts.

### MADE TO MEASURE DOOR SURCHARGES

For Pricing of made to measure Doors and Drawer Fronts, use next standard size up and add 10%.

### HINGE HOLES

35mm diameter x 13mm depth.

### Colour Surcharges

COLOUR	A	B	COLOUR	A	B	COLOUR	A	B
Supermatt Cashmere	■		Serica Matt Indigo Blue	■		Ultragloss Light Grey		■
Supermatt Dust Grey	■		Serica Matt Black	■		Ultragloss Stone Grey		■
Supermatt Graphite	■		Ultragloss Baltic Blue		■	Ultragloss Limestone		■
Supermatt Light Grey	■		Ultragloss Black		■	Ultragloss Metallic Anthracite		■
Supermatt White	■		Ultragloss Cashmere		■	Ultragloss Metallic Blue		■
Serica Matt Pebble	■		Ultragloss Copperleaf		■	Ultragloss Metallic Champagne		■
Serica Matt Taupe	■		Ultragloss Glacier White		■	Ultragloss White		■
Serica Matt Kombu Green	■		Ultragloss Cream		■	Brushed Metal Stainless Steel		■
Serica Matt Plum	■		Ultragloss Japanese Pear		■			





### PLAIN DOORS

715 x 298 x 298 Wall/Base Door

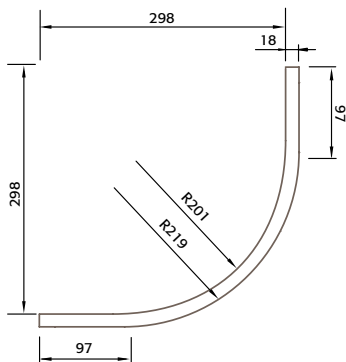

### CABINET

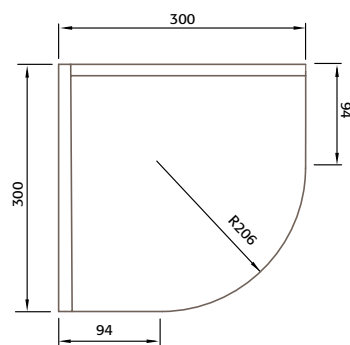

### BASE CABINET

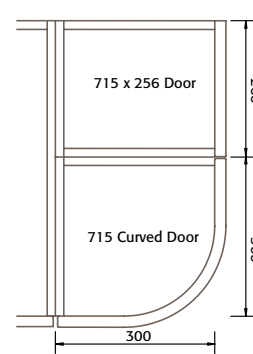

### WALL CABINET

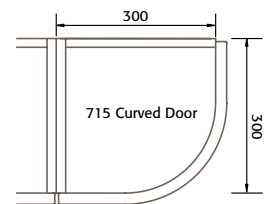

### CURVED MULTI-PURPOSE RAIL (CORNICHE)

Fit front edge flush with front of curved door

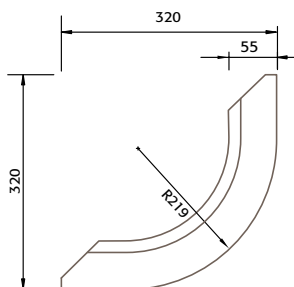

### 150 HIGH CURVED PLINTH (KITCHEN)

Fit front edge 50mm back from edge of carcass

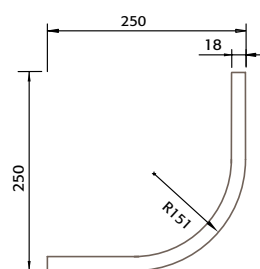

### BELLA CURVED DOOR CABINET

Vinyl wrapped components. Some colours do not have a matching back, see pages 72-73. 720mm x 300mm x 300mm (2 shelves). Code: **ACDC7**

For Zurfiz curved door cabinets order from the Bella colour options.

Not available in Opengrain White.







See page 108 for A & B colour surcharges

### Plinth

Plinth is available in any height between 100mm and 150mm x 3M long. Exceptions: UG Limestone and Copperleaf = 2.715M L. Supplied with matching edging on one long edge. Code: **AZPLINTH**

### Aluminium Plinth

150mm H x 3M L  
Pack of 10 clips included. Code: **AAP**

### End Panels

Edged 4 sides - edging supplied as doors ordered, unless specified. Refer to page 106-107 for Back Colours of End Panels.

900 x 350mm  
900 x 650mm  
2400 x 650mm

### Made to Measure Panels/Tops (edged 4 sides)

Available any size from 100 > 2540mm L x 100 > 1200mm W.

### Raw Edge Panels (not edged)

Available any size from 100 > 2540mm L x 100 > 1200mm W.

## Wrap Around End Panels

### WRAP AROUND C-PANEL

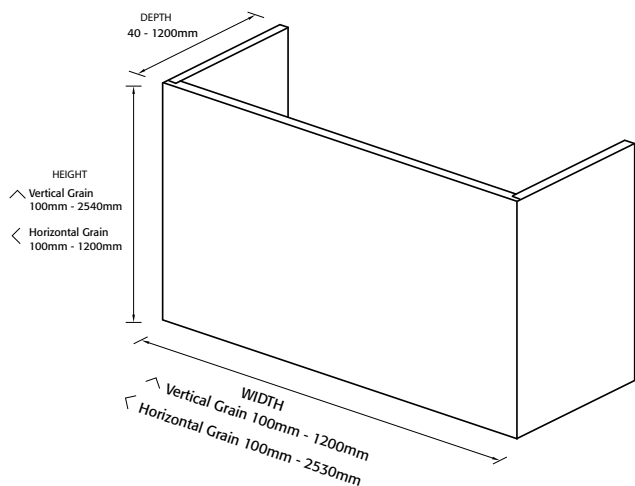

### WRAP AROUND G-PANEL

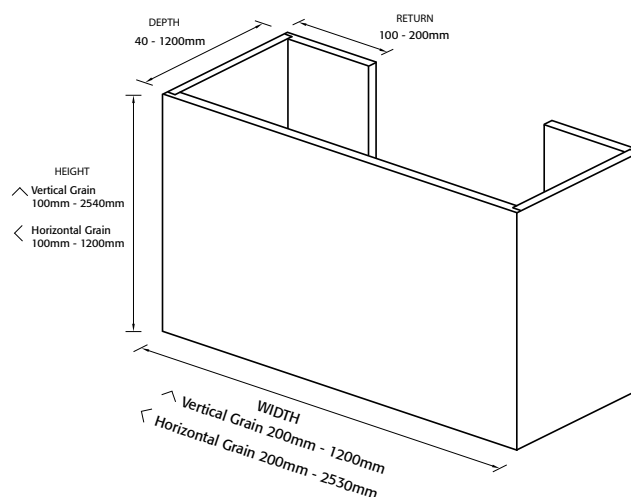

- All panels are 18mm thick and when constructed will have no visible raw edges.
- All panels supplied with a doweled Butt joint for easy assembly.
- Handleless Rail End Panels - use C-Panel with depth of 45mm.
- All panels are vertical grain unless otherwise specified.
- Not available in glass effect edging .
- On G Panel for widths 400mm or less Returns should be 100mm.

### Wrap Around C-Panel

Price per m<sup>2</sup> (3 panels)

Code: **AZPWAC**

### Wrap Around G-Panel

Price per m<sup>2</sup> (5 panels)

Code: **AZPWAG**

See page 108 for A & B colour surcharges.

# Cabinets

NEW



# Cabinets

## ClicBox

ClicBox By BA is an unique concept in kitchen cabinets. Using the patented UNICLIC for furniture technology, means the different components just clic together. This is set to revolutionise cabinet assembly.



### The UNICLIC technology

The UNICLIC technology is a tongue and groove solution which enables a click connection at an angle of 90°. This revolutionary technology makes it possible to assemble flat packed kitchen cabinets by simply clicking the components together, without requiring any tools or screws!



### Stronger Connection

The click connection is stronger than a traditional assembly system as the joints interlock along the entire assembly length instead of only on 2 fixing points.

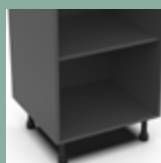

### No Visible Fittings

As there are no fittings required with UNICLIC, the technology is completely invisible.



Product

Cert No. PC0051

The ClicBox Kitchen Range has been tested at FIRA International Ltd and successfully meets the structural performance requirements for FIRA Gold certification to Heavy Domestic / Contract Kitchen Furniture: FPG S006 – Level H Specification.



Watch the ClicBox video to see how easy & quick assembly is. [byba.co.uk/clicbox](http://byba.co.uk/clicbox)

Easy as  
**1 - 2 - 3**

0:00



0:06

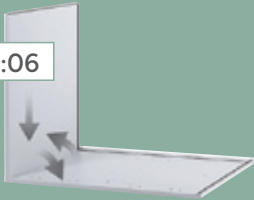

0:15



0:24



0:30



- Assemble on site
- No tools, no missing fittings
- Less chance of damage in transit
- 67% saving in vehicle space
- Suitable for limited access areas
- Ideal for multiple floor buildings
- Less time, more profit
- Standard size cabinets despatched in 24 hours.

## Product features that make the difference

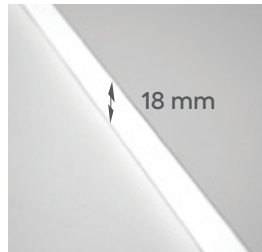

18mm thick MFC panels, 1mm ABS on leading edges

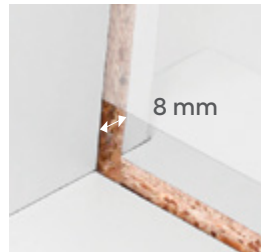

8mm solid MDF back

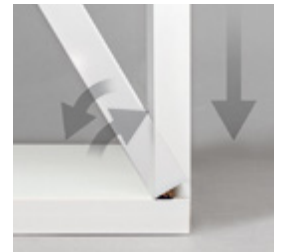

No fittings because of UNICLIC technology



Solid top and bottom are interchangeable



18mm adjustable shelves; 3 possible heights



Tool-less adjustable legs. Height - 150mm



Tool-less solid centerpost with a unique Turnfastener technology



Tool-less and adjustable concealed hanging bracket system



Wall Cabinets are 330mm deep with 18mm void. Internal depth 304mm



Base Cabinets are 570mm deep with 49mm void. Internal depth 513mm



Cover Caps 5mm colour matched and come as standard with every cabinet order



The mark of responsible forestry

ClicBox is FSC® Certified



## Colours available

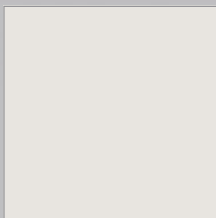

**White**

Kronospan: K101

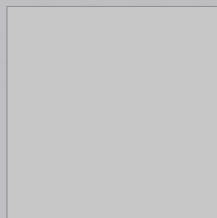

**Grey**

Kronospan: 0112



**Dust Grey**

Kronospan: 0171



**Anthracite**

Kronospan: 0164

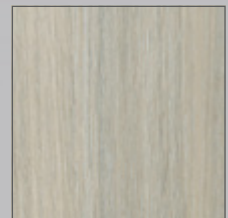

**Urban Oak**

Kronospan: K005

# Cabinets

## Base Cabinets

ClicBox cabinet range is pre-drilled to suit Hettich hinges and drawers (page 126-128).

- All base Cabinets are 720mm H x 570mm D
- Includes tool-less adjustable legs 150mm H
- Hinge plate positions are centred 100mm top and bottom to suit a door drilling of 98mm top and bottom
- Hinge plate positions are pre drilled for euro screws



Highline Base

150 Wide

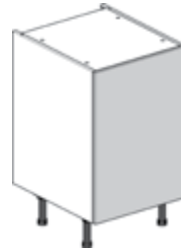

Highline Base

300/400/450/500/600 Wide



Highline Double Base

700/800/900/1000 Wide

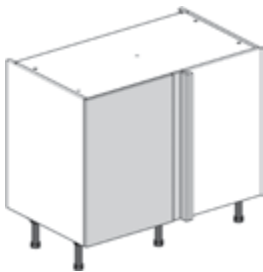

Blind Corner

1000 Wide



Drawerline Base

300/400/450/500/600 Wide



Drawerline Double Base

800/900/1000 Wide

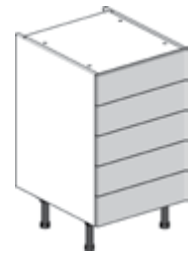

5-Drawer Pack

(5 standard drawers)  
300/500/600 Wide

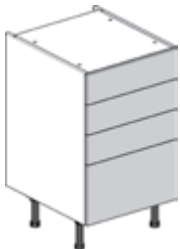

4-Drawer Pack

(3 standard + 1 pan drawer)  
500/600 Wide

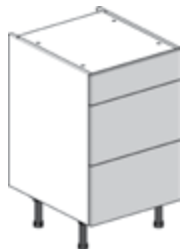

3-Drawer Pack

(1 standard + 2 pan drawers)  
500/600/800/900/1000 Wide

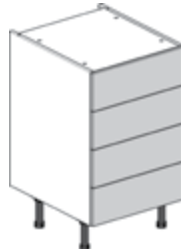

4-Drawer Pack

(4 standard drawers)  
400/500/600 Wide

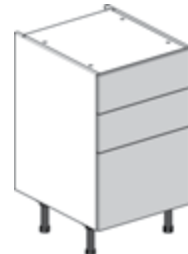

3-Drawer Pack

(2 standard + 1 pan drawer)  
500/600 Wide

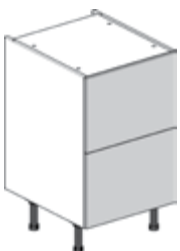

2-Drawer Pack

(2 pan drawers)  
500/600/800/900/1000 Wide



Base Under Oven

600 Wide

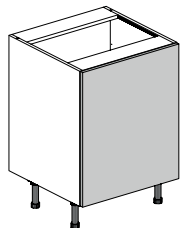

Sink Base

600 wide



Belfast Sink

600 Wide

# Cabinets

## Wall Cabinets

- Wall Cabinets are 575mm (short) 720mm (standard) & 900mm (tall) H x 330mm D
- Bridging Cabinets are 283mm (short) & 360mm (standard) H x 330mm D
- Includes tool-less adjustable hanging brackets
- Hinge plate positions are centred 100mm top and bottom to suit a door drilling of 98mm top and bottom
- Hinge plate positions are pre-drilled for euro screws



Wall (short)

300/400/450/500/600 Wide

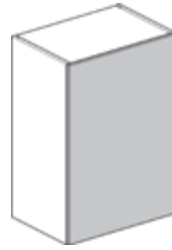

Wall

300/400/450/500/600 Wide

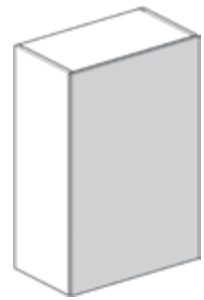

Wall (tall)

300/400/500/600 Wide

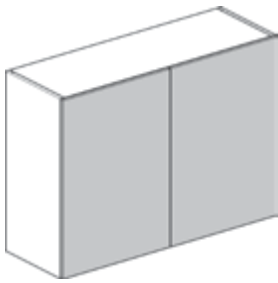

Double Wall

700/800/900/1000 Wide

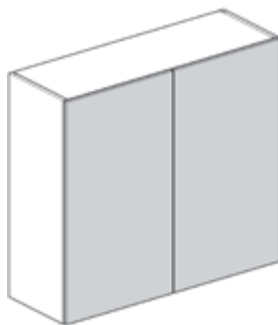

Double Wall (tall)

800/1000 Wide

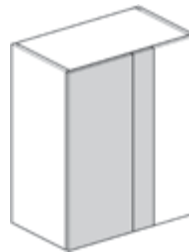

Blind Corner Wall

600 Wide

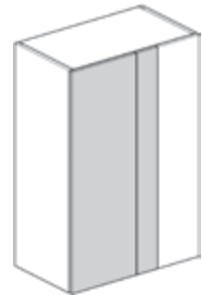

Blind Corner Wall (tall)

600 Wide



Bridging (short)

500/600 Wide

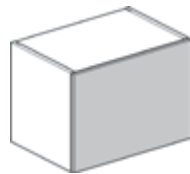

Bridging

500/600/800/900 Wide

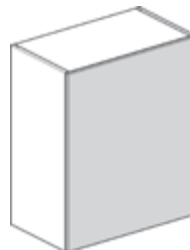

Boiler Cabinet

(Ready to Assemble)  
600 Wide (450D, no back)

# Cabinets

## Tower Cabinets

- Tower Cabinets are 1970mm (standard) & 2150mm (tall) H x 570mm D
- Hinge plate positions are pre-drilled for euro screws
- Includes tool-less adjustable legs 150mm H
- Shelf packs included



Larder (standard)

300/400/500/600 Wide

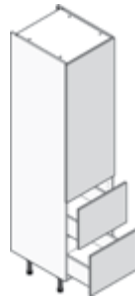

Larder with 2 Pan Drawers (standard)

500/600 Wide



Larder with Inner Drawers (standard)

500/600 Wide



Larder with One Door (standard)

300/400/500/600 Wide



Larder (tall)

300/400/500/600 Wide

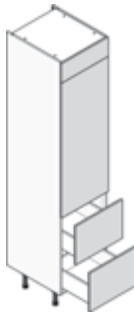

Larder with 2 Pan Drawers (tall)

500/600 Wide

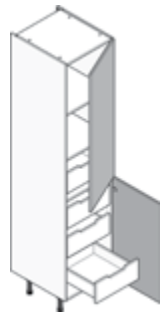

Larder with Inner Drawers (tall)

500/600 Wide



Larder with 1425 & 715 Doors (tall)

300/400/500/600 Wide



Larder with One Door (tall)

300/400/500/600 Wide



Single Oven (standard)

600 Wide

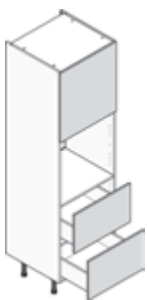

Single Oven with 2 Pan Drawers (standard)

600 Wide



Double Oven (standard)

600 Wide

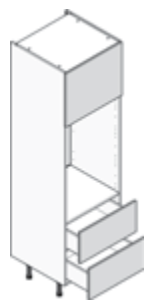

Double Oven with 2 Pan Drawers (standard)

600 Wide



Single Oven + Compact/Microwave (standard)

600 Wide

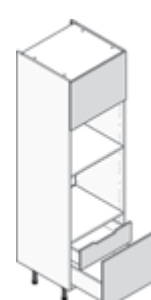

Single Oven + Compact/Microwave with 1 Pan Drawer + 1 Inner Drawer (standard)

600 Wide



Compact/Microwave (standard)

600 Wide



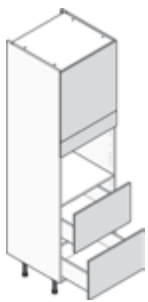

Compact/Microwave with 2 Pan Drawers (standard)

600 Wide



Single Oven (tall)

600 Wide

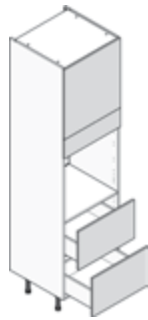

Single Oven with 2 Pan Drawers (tall)

600 Wide



Double Oven (tall)

600 Wide

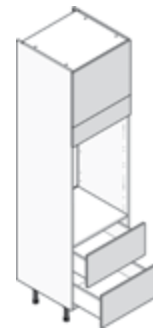

Double Oven with 2 Pan Drawers (tall)

600 Wide

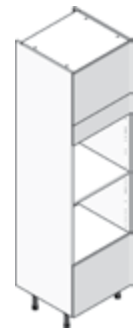

Single Oven + Compact / Microwave (tall)

600 Wide

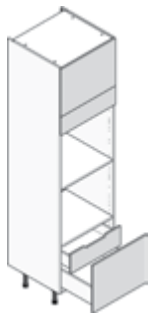

Single Oven + Compact / Microwave with 1 Pan Drawer + 1 Inner Drawer (tall)

600 Wide



Compact / Microwave (tall)

600 Wide

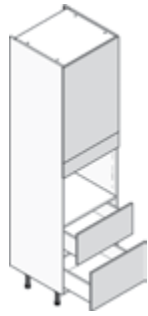

Compact/Microwave with 2 Pan Drawers (tall)

600 Wide



70/30 Cooling (standard)

600 Wide



50/50 Cooling (standard)

600 Wide



Single Cooling (standard)

600 Wide

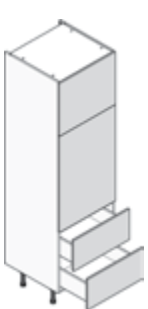

Single Cooling with 2 Pan Drawers (standard)

600 Wide



70/30 Cooling (tall)

600 Wide

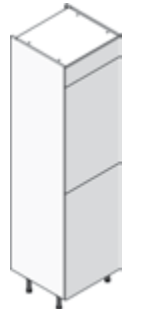

50/50 Cooling (tall)

600 Wide



Single Cooling (tall)

600 Wide

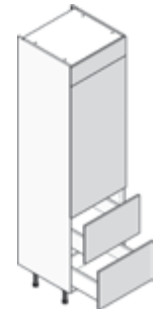

Single Cooling with 2 Pan Drawers (tall)

600 Wide

# Cabinets

## Blind Corner Units

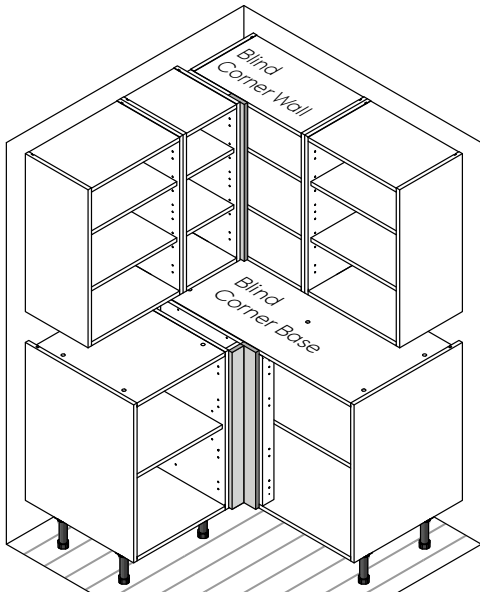

Blind Corner units are available in a variety of standard sizes, giving numerous options on planning out of a corner. Standard door and cabinet combinations are shown below – the system can be further tailored during installation, by trimming the corner post, and positioning of the cabinetry as shown opposite.

### Standard Blind Corner Wall Unit (650 x 350)

This uses a standard 600 cabinet, together with a 300 door. Only one part of the corner post is required (80mm), together with blind corner hinges, which are used to hang the door off the rear face of the 80mm panel. The 61mm corner return is also supplied, should the unit need adjustment as shown opposite.

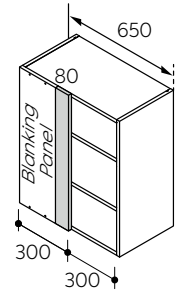

Always check any handle sizes for clearances that may be needed, and adjust the size of the corner post as necessary.

### Two Part Corner Post

This is supplied in flat format to allow customisation on-site. In its maximum size, it measures 80 x 80mm when assembled. The 80mm piece is pre-drilled on the rear face for hinge mounting plates (Blind Corner Wall unit Door Hanging).

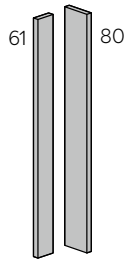

### Standard Blind Corner Base Unit (1150 x 650)

This uses a standard 1000mm base cabinet, together with a 500mm door – other combinations are available, see below. Both parts of the corner post are required, and can be modified during installation as shown opposite.

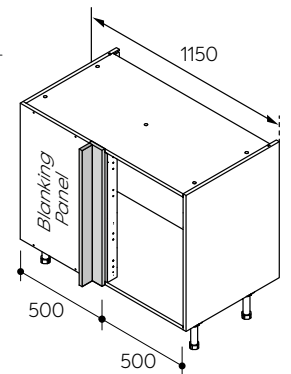

### Standard Corner Base Options

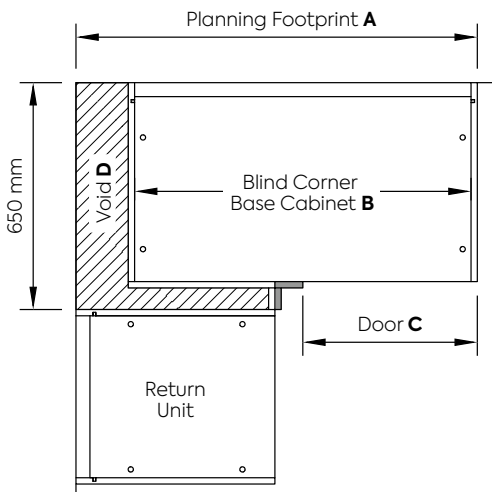

Blind corner base units are available in a variety of cabinet & door combinations as listed – they will all work with the 650 x 350 Blind Corner Wall unit above, together with the relevant size of return wall units.

Planning Footprint A	Cabinet B	Door C	Void D
1000	700	350	300
1050	800	400	250
1100	900	450	200
1150	1000	500	150
1100	1000	450	100
1050	1000	400	50
1250	1000	600	250

# Cabinets

## Blind Corner Units – Flexible Corner Planning

The nature of the two-part corner post is inherently flexible – it can be tailored during installation to achieve any corner configuration size required. This can be used when planning the overall kitchen design to remove the need for unsightly infill strips. Two typical specimen examples are shown below, however the corner planning options are limitless with a degree of thought, and careful planning.

Note: the 80mm panel does not need trimming in any scenario – the relevant base or wall cabinet is simply positioned further in (or out) of the corner, creating more (or less) reveal of the 80mm panel. The 61mm return piece is then trimmed and positioned accordingly.

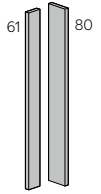

### Example 1 – 1125mm Corner

- The blind corner wall cabinet is set at 675mm, with a 75mm void – making the corner post footprint 45 x 45 (26 x 26 visible)
- Standard 450mm wall units are used to align with the base units below
- The 1000mm blind corner base is set at 1125mm, with a 125mm void – making the corner post footprint 55 x 55 (36 x 36 visible).

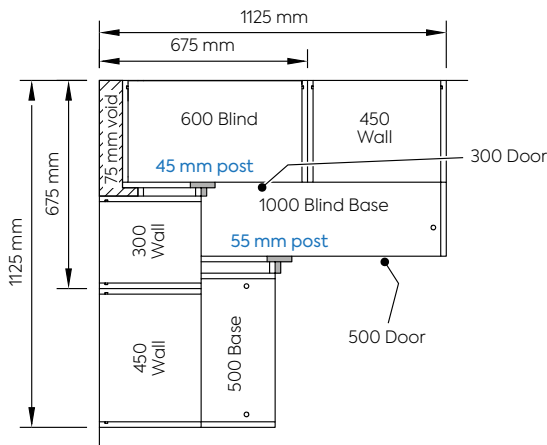

### Example 2 – 1100mm Corner

- The blind corner wall is set at 700mm, with a 100mm void – making the corner post footprint 70 x 70 (51 x 51 visible).
- Standard 400mm wall units are used to align with the base units below.
- The 900mm blind corner base is set at 1100mm, with a 200mm void – making the corner post footprint 80 x 80 (does not need trimming) and a 450mm base return unit.

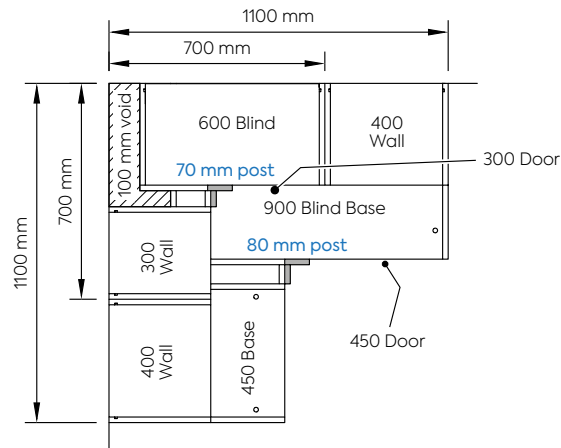

### J-Pull Ranges: Jayline and Lacarre

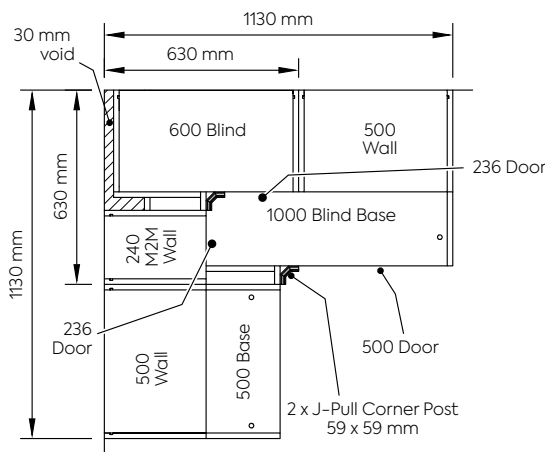

- For J-Pull ranges the corner post is a fixed size 59 x 59, with J-Pull design, used on both base and wall units to suit a 630 (Wall) and 1130 (Base) planning footprint.
- A 236mm corner wall door is used – note that this is hinged from the cabinet end panel using 165 degree hinges.
- A made-to-measure return wall unit (240mm wide) can be used together with a 236mm wide door, to align with the base units below, if required to match the overall kitchen plan.

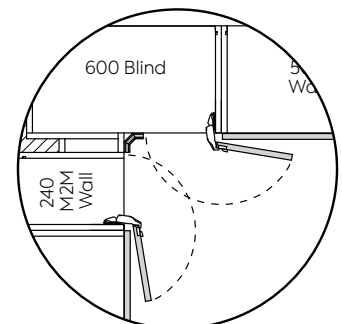
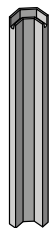

# Tallstor™

Storage Solution



Integra style Internal Drawers  
matching the frontal colour  
(Bella range only)

# Tallstor™

Introducing Tallstor™, our unique stylish storage solution giving your customers even more choice. Internal drawers can now match cabinet colours, drawer boxes or frontal colours.



**Option 1**

Internal drawers matching the cabinet colour



**Option 2**

Internal drawers matching the frontal colour

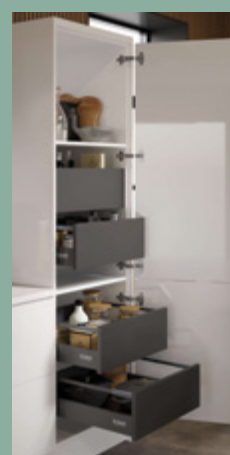

**Option 3**

Internal drawers matching the drawer boxes



Also available for base cabinet, shown here with 3 drawers.  
Multiple drawer options available.



Internal drawers matching the frontal colour



Order your today on MyBA

# Tallstor

## Butler's Pantries

---

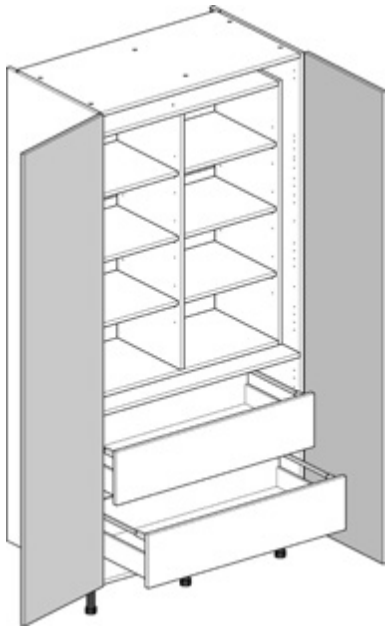

Butler's Pantry with  
2x Internal Drawers (standard)

1000 Wide

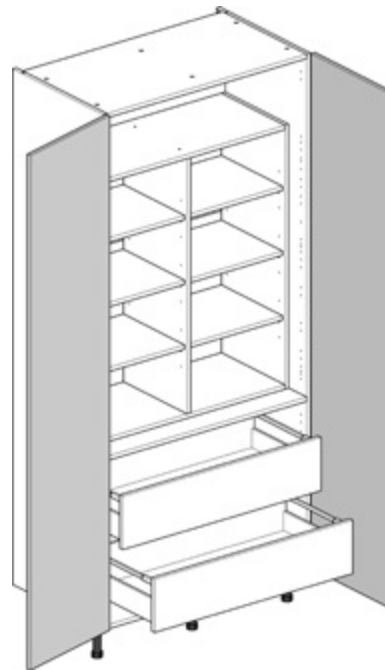

Butler's Pantry with  
2x Internal Drawers (tall)

1000 Wide

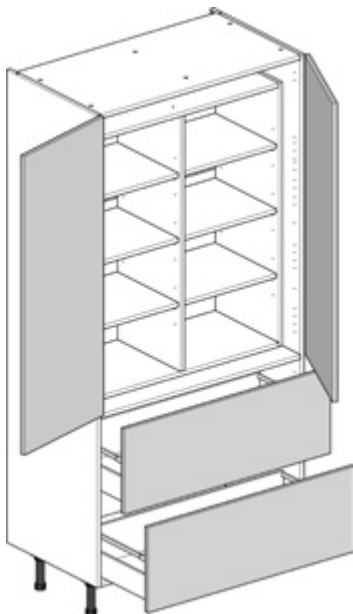

Butler's Pantry with  
2x 355 Drawers (standard)

1000 Wide

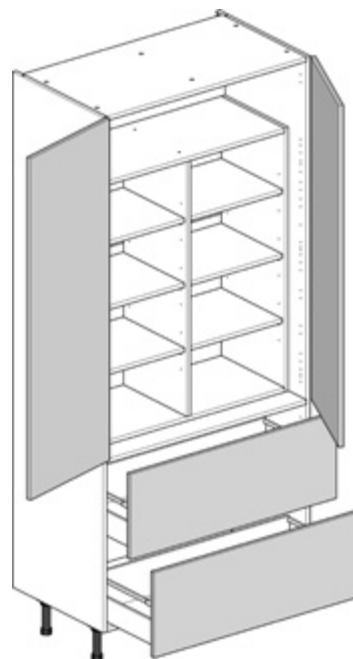

Butler's Pantry with  
2x 355 Drawers (tall)

1000 Wide



### A range of top quality Sensys & Intermat hinges from Hettich.

Tool-less snap on hinge to plate. Hinge plates are not supplied with hinges and must be ordered separately. Images show hinges with covers that are not supplied.



**110° soft close Hinge (Sensys 8645i)**

110° opening angle, soft close, 3 way adjustment, screw fix cup. For use on standard cabinets.  
Silver: H110SCHIN  
Black: HB110SCHIN



**165° Soft Close Hinge (Sensys 8657i)**

165° opening angle, soft close, 3 way adjustment, screw fix cup. For use on corner cabinets.  
Silver: H165SCHIN  
Black: HB165SCHIN



**45° Angled Cabinet Hinge (Sensys 8639i W45)**

95° opening angle, soft close, 3 way adjustment, screw fix cup. For use on 45° angled cabinets.  
Silver: HSCHINAC  
Black: HBSCHINAC



**Bi-fold Hinge (Intermat 9930)**

50° - 65° opening angle, 3 way adjustment, screw fix cup. For use on corner cabinets.  
Silver: HBFHIN  
Black: HBBFHIN



**Intermat 110° Hinge for Integrated Fridge Freezer**

For use with cross mounting plate for integrated fridge freezer (HCMPIFF)  
Silver: H110IFF



**Cross Mounting Plate for Integrated Fridge Freezer**

To be used with Intermat 110 hinge for Fridge Freezer  
Silver: HCMPIFF



**Standard Hinge Mounting Plate (9071625)**

Manual height adjustment +/- 3mm, 0.5mm rise, Euro screws. Suitable for Sensys & Intermat Hinges.  
Silver: HSHMPES  
Black: HBSHMPES



**Cam Adjustable Hinge Mounting Plate (9071665)**

Cam height adjustment +/- 3mm, 0.5mm rise, Euro screws. Suitable for Sensys & Intermat Hinges.  
Silver: HAHMPES  
Black: HBAHMPES



**Blum Aventos HK-S Flap Door hinging system**

With clip-on, fully adjustable door assembly and adjustable soft-closing mechanism that can be tailored to suit individual door weights. To suit doors up to 355mm high, and up to 900mm wide. Supplied with door fixing bracket, and light grey cover clips.  
Code: HFLAPHINB



**Wingline Kit (Left & Right)**

Kit Only, does not include doors, cabinets nor internals. Suitable for full height wardrobe doors, from 300mm to 600mm in width, and between 1800mm and 2200mm in height.  
Left: BRKWLL  
Right: BRKWLR

## Push to open options (for Handleless doors and drawers)



**110° Hinge (not soft close) (Sensys 8645)**

110° opening angle, 3 way adjustment, screw fix cup. For use with push to open pin.  
Silver: H110NSCHIN  
Black: HB110NSCHIN



**165° Hinge (not soft close) (Sensys 8657)**

165° opening angle, 3 way adjustment, screw fix cup. For use with push to open pin.  
Silver: H165NSCHIN  
Black: HB165NSCHIN



**Push to Open Door Pin**

Must be used in conjunction with non-soft close hinges. Screw fix.  
Grey: HPTOP  
Black: HBPTOP



**For Push to Open Drawer options**

See page 127



**Hinge Cover Caps**

25 of each in pack (50 pieces)  
Black: HBHCC



We stock all components necessary including Hettich machinery to produce top quality pre-assembled Atira soft close drawers so you don't have to...

Each drawer comes in 2 colours ready assembled and includes all components and screws required, shrink wrapped and individually boxed. **A Drawer in a Box...**



Silver



Graphite

Our Clicbox cabinets come in 5 colours and are predrilled to suit Hettich Atira drawers.

### Drawer Specifications

Durable powder coated silver/graphite colour. Double wall steel sides & back with matching silver/graphite 16mm MFC base. Quadro silent soft close self cleaning runners with full 470 extension. 470mm deep drawer. 30kg load capacity. Tool-less height adjustment by thumb wheel (+/- 2mm). Easy lateral adjustment by screw driver (+/- 1.5mm).

#### Push to open option

Atira Standard and High Sided Drawers are available with 'Push to Open' drawer runners. (Not Soft Close) State PTO when ordering.



#### Adjustable Drawer Divider Kits

Silver/Graphite divider kit to suit Atira High Sided Drawers. Kit includes 1 spring loaded divider plus cross dividers as follows: 600 W x 3, 800 W x 4, 900/1000 x 5. **Codes below are for silver option. For graphite, add 'G' after 'H' e.g. HGADDK600**  
 600mm W. Code: **HADDK600**  
 800mm W. Code: **HADDK800**  
 900mm W. Code: **HADDK900**  
 1000mm W. Code: **HADDK1000**



#### Cutlery/Organiser Trays to fit Atira Drawers

Silver/Graphite moulded trays with adjustable dividers. **Codes below are for silver option. For graphite, add 'G' after 'H' e.g. HGCT500SOT590**  
 500mm W. Code **HCT500SOT590**  
 600mm W. Code **HCT600SOT590**  
 800mm W. Code **HCT800SOT590**  
 900mm W. Code **HCT900SOT590**  
 1000mm W. Code **HCT1000SOT590**



#### Atira Standard Drawers

Drawer height 70mm. Each drawer pack includes: Drawer, pair of runners, 2 x drawer front connectors, 2 x Hettich covers, screw pack (4 x euro screws & 4 x wood screws for runners, 4 x wood screws for drawer front connectors). Codes below are for silver option. For graphite, add 'G' after 'H' e.g. HGADS300SIN

300mm W. Code: **HADS300SIN**  
 400mm W. Code: **HADS400SIN**  
 450mm W. Code: **HADS450SIN**  
 500mm W. Code: **HADS500SIN**  
 600mm W. Code: **HADS600SIN**  
 800mm W. Code: **HADS800SIN**  
 900mm W. Code: **HADS900SIN**  
 1000mm W. Code: **HADS1000SIN**



#### Atira High Sided Drawers

Drawer height 144mm. Each drawer pack includes: Drawer, pair of runners, 2 x side rails & connectors, 2 x drawer front connectors, 2 x Hettich covers, screw pack (4 x euro screws & 4 x wood screws for runners, 2 x screws for side rails, 4 x wood screws for drawer front connectors). Codes below are for silver option. For graphite, add 'G' after 'H' e.g. HGADP500SIN

300mm W. Code: **HADP300SIN**  
 400mm W. Code: **HADP400SIN**  
 500mm W. Code: **HADP500SIN**  
 600mm W. Code: **HADP600SIN**  
 800mm W. Code: **HADP800SIN**  
 900mm W. Code: **HADP900SIN**  
 1000mm W. Code: **HADP1000SIN**

#### Cross Rail Dividers

(pack of 15) Silver/Graphite drawer divider kit.  
 Code: H15CRDDK (Silver) HG15CRDDK (Graphite)

- Stylish Design in Silver/ Graphite Finish
- Quadro Silence Soft Close
- 30kg Load Capacity (per drawer)
- Strong and Robust
- Full Drawer Extension
- Flexible Internal Accessories



### Front Panel For Converting Standard Drawer to an Internal Storage Drawer

Order drawers separately. Drawer runners set back 32mm. Codes below are for silver option.

For graphite, add 'G' after 'H' e.g. HGIFP ASD400

400mm W. Code: HIFP ASD400  
 500mm W. Code: HIFP ASD500  
 600mm W. Code: HIFP ASD600  
 800mm W. Code: HIFP ASD800  
 900mm W. Code: HIFP ASD900  
 1000mm W. Code: HIFP ASD1000

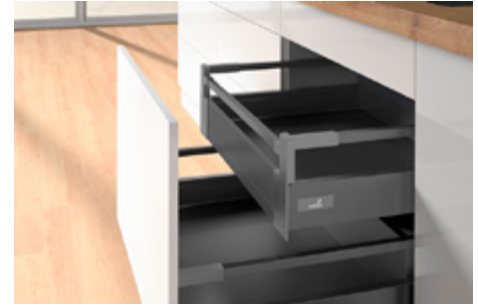

### Front Panel For Converting High Sided Drawer to an Internal Storage Drawer

Order drawers separately. Drawer runners set back 32mm. Codes below are for silver option.

For graphite, add 'G' after 'H' e.g. HGIFP AHD500

500mm W. Code: HIFP AHD500  
 600mm W. Code: HIFP AHD600



### Under Sink Drawer Conversion Kit

Powder coated silver/graphite U Bend. MFC back supplied to be cut to suit drawer width. U Bend 210 L x 146 W x 65 H. Kit to convert any Atira Standard or High Sided Drawer 300 W up to 1000 W.

Standard Drawer.  
 Code: HUSDCK70 (Silver), HUSDCK70 (Graphite)  
 High Sided Drawer.  
 Code: HUSDCK144 (Silver), HUSDCK144 (Graphite)



### Glass Side Kit

Glass Side Kit to suit Atira High Sided Drawers. Kit contains 2 x Glass Sides with pre-mounted adapters + drawer front connectors.

Code: HGSK (Silver)  
 Code: HGGSK (Graphite)

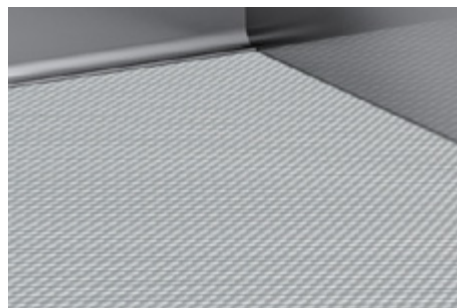

### Anti Slip Matting

Matting for drawer base supplied in a roll 470mm D x 5m L.

Code: HASM (Silver)  
 Code: HGASM (Graphite)

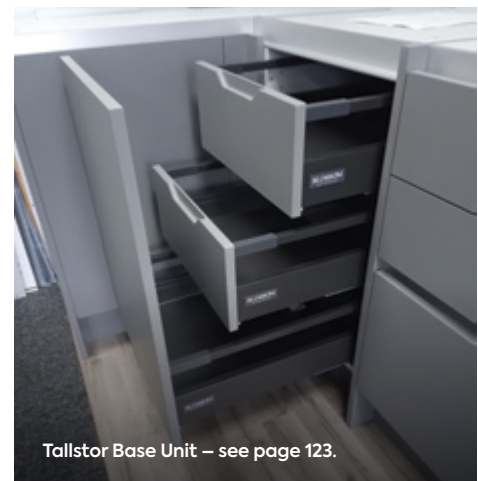

Tallstor Base Unit – see page 123.



- Soft Closing Mechanism
- Full Extension runners
- Contemporary Grey Finish
- Grey Linen effect solid base panel
- Adjustable Door Fixing
- Fitting instructions supplied



**150 Base Pull Out**  
500 deep. To suit a 150 x 720 base cabinet. 15Kg loading. Code: **STORANT0001**



**300 Base Pull Out**  
500 deep. To suit a 300 x 720 base cabinet. 30Kg loading. Code: **STORANT0002**



**300 Pull Out Larder**  
500 deep. To suit a 300w tall cabinet. Five baskets, height adjustable. 120Kg loading. Code: **STORANT0003**



**500 Swing Out Larder**  
470 deep. 1880 high. To suit a 500w tall cabinet. Five baskets, height adjustable. 80Kg loading. Code: **STORANT0004**



**Nuvola Corner Storage System**  
Two widths to suit 450 and 500 doors (for 900 and 1000 cabinets). Left and right handed, two carousels per set, 25Kg loading. The upper carousel fixes to cabinet shelf. For door clearance we recommend using our slimline hinge – H110IFF.

- 450mm W. LH. Use with right hand blank corner. Code: **STORANT0005**
- 450mm W. RH. Use with left hand blank corner. Code: **STORANT0006**
- 500mm W. LH. Use with right hand blank corner. Code: **STORANT0007**
- 500mm W. RH. Use with left hand blank corner. Code: **STORANT0008**





### Undersink Storage Bin 28L

28L two bin system, simple pull out action, ideal for compact spaces, 450mm deep, 255w x 390mm h.  
Code: STORANT0009



### Cargo Waste Storage systems

- Soft closing mechanism
- Full extension runners
- Contemporary grey finish
- Integral bin lid
- Fitting instructions supplied
- Removable bin for ease of access and cleaning



### 300 Pull-Out Cargo Bin

Fits a 715 Highline Door, with adjustable fixings. 505mm deep. 40Kg loading.  
Code: STORANT0010



### 400 Pull-Out Cargo Bin

Fits a 715 Highline Door, with adjustable fixings. 505mm deep. 40Kg loading.  
Code: STORANT0011



### 500 Pull-Out Cargo Bin

Two bin system. Fits a 715 Highline Door, with adjustable fixings. 505mm deep. 40Kg loading.  
Code: STORANT0012



### 600 Pull-Out Cargo Bin

Four bin system. Fits a 715 Highline Door, with adjustable fixings. 505mm deep. 40Kg loading.  
Code: STORANT0013





# Handles





# Handles

Our collection of door handles and knobs can be perfectly teamed to achieve a sophisticated space – one you'll be operating with ease. Explore our ranges to unlock affordable ideas for your doors and drawers, including a variety of shapes, sizes, and colours.

Bringing furniture to life, through craftsmanship and design. Introducing our new handle collections, Hendel & Hendel.

# Handles

## Oval End D Handle



Satin Chrome  
Length: 166mm  
Drilling: 128mm  
Code: AHODH

## Bridge Handle



Satin Chrome  
Length: 180mm  
Drilling: 160mm  
Code: AH180BBN

## Flat Bar Handle



Satin Chrome  
Length: 193mm  
Drilling: 160mm  
Code: AHFBAR

## D Handle



Satin Nickel  
Length: 126mm  
Drilling: 96mm  
Code: AHDH

## Round Knob



Satin Chrome  
Diameter: 32mm  
Code: AHRK

## Bow Handle



Satin Chrome  
Length: 160mm  
Drilling: 128mm  
Code: AHBOW

## Rail Bar Handle



Stainless Steel  
Length: 167mm  
Drilling: 128mm  
Code: AHAND19

## Crystal Knob



Cast Iron, Chrome  
Diameter: 35mm  
Code: AHCRYK

## Tapered Bow Handle



Satin Chrome  
Length: 184mm  
Drilling: 128mm  
Code: AHTBH

## Bordeaux Knob



Cast Iron  
Diameter: 35mm  
Code: AHBOK

## Flat Bow Handle



Satin Chrome  
Length: 144mm  
Drilling: 128mm  
Code: AHFBH

## Twist Handle



Chrome  
Length: 138mm  
Drilling: 128mm  
Code: AHTWIH1

## Shell Handle



Satin Nickel  
Length: 94mm  
Drilling: 64mm  
Code: AHSBH

## Stepped Taper Handle



Stainless Steel  
Length: 175mm  
Drilling: 160mm  
Code: AHSTEH

## Satin Chrome/Chrome Bar Handle



Satin Chrome/Chrome  
Length: 176mm  
Drilling: 160mm  
Code: AHACBH





### Windsor Shell



Chrome  
Length: 125mm  
Drilling: 96mm  
Code: AHWSC



Satin Chrome  
Length: 125mm  
Drilling: 96mm  
Code: AHWSBN



Pewter  
Length: 125mm  
Drilling: 96mm  
Code: HWSP



Brushed Copper  
Length: 125mm  
Drilling: 96mm  
Code: AHWSAC



Satin Brass  
Length: 125mm  
Drilling: 96mm  
Code: AHAND10

### Windsor Knob



Chrome  
Diameter: 38mm  
Code: HWKC



Satin Chrome  
Diameter: 38mm  
Code: AHWKBN



Pewter  
Diameter: 38mm  
Code: HWKP



Brushed Copper  
Diameter: 38mm  
Code: AHWKAC



Satin Brass  
Diameter: 38mm  
Code: AHAND9

### Button Knob



Chrome  
Diameter: 31mm  
Code: AHBUKNCH



Matt Black  
Diameter: 31mm  
Code: AHBUKNBL

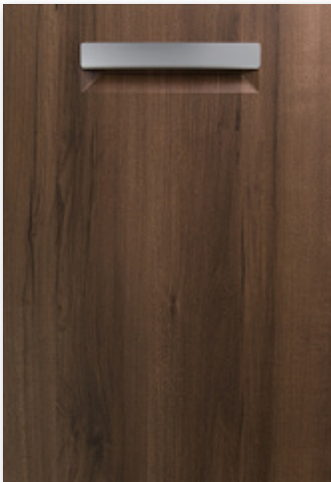
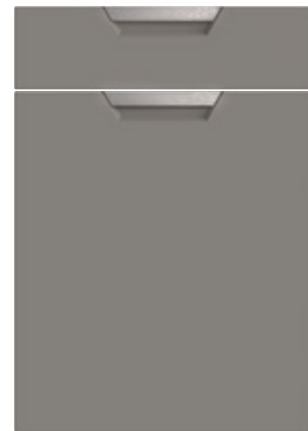

### Lazio Handle

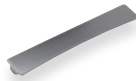

Satin Chrome  
Length: 210mm  
Drilling: 192mm  
Code: AHLSC



Matt Black  
Length: 210mm  
Drilling: 192mm  
Code: AHLMB

Lazio available to order in Bella.

### Segreto Handle



Brushed Nickel  
Length: 198mm  
Drilling: 96mm  
Code: AHSEGBN198



Dark Brushed Steel  
Length: 198mm  
Drilling: 96mm  
Code: AHSEGBS198

Segreto available to order in Bella.

### Handle Drilling Jig

Heavy Duty Plastic. For easy and accurate marking of handle positions.  
Code: AHJIG

Note: Remember when planning a kitchen/bedroom, some handles will not fit small drawer fronts.

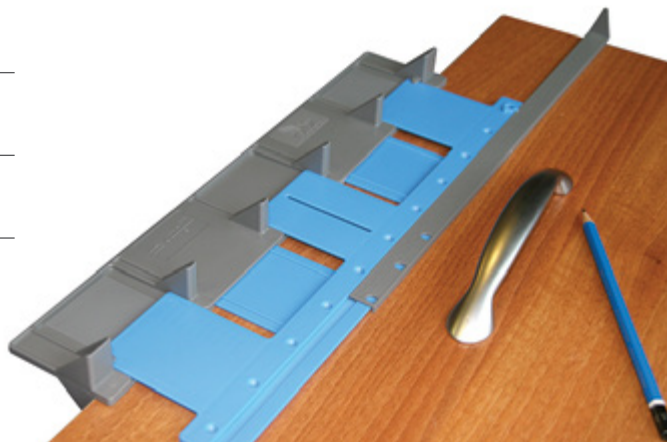

# Handles

## Slimline Handle



Brushed Copper  
Length: 144mm  
Drilling: 128mm  
Code: AHSLCO144



Stainless Steel  
Length: 144mm  
Drilling: 128mm  
Code: AHSLSS144



Brushed Copper  
Length: 336mm  
Drilling: 320mm  
Code: AHSLCO336



Stainless Steel  
Length: 336mm  
Drilling: 320mm  
Code: AHSLSS336

## 14mm Bar Handle



Stainless Steel  
Length: 188mm  
Drilling: 160mm  
Code: AHBH1



Stainless Steel  
Length: 337mm  
Drilling: 309mm  
Code: AHBH3

## Wedge Bar Handle



Matt Black  
Length: 203mm  
Drilling: 192mm  
Code: AHWB203



Matt Black  
Length: 337mm  
Drilling: 320mm  
Code: AHWB337

## Knurled T Bar Handle



Matt Black  
Length: 220mm  
Drilling: 160mm  
Code: AHAND15



Brushed Nickel  
Length: 220mm  
Drilling: 160mm  
Code: AHAND13



Brushed Nickel  
Length: 284mm  
Drilling: 224mm  
Code: AHAND14

## T Bar Handle



Matt Black  
Length: 167mm  
Drilling: 128mm  
Code: AHAND20



Stainless Steel  
Length: 186mm  
Drilling: 128mm  
Code: AHTBH1



Stainless Steel  
Length: 244mm  
Drilling: 184mm  
Code: AHTBH2



Stainless Steel  
Length: 337mm  
Drilling: 277mm  
Code: AHTBH3



Stainless Steel  
Length: 426mm  
Drilling: 357mm  
Code: AHTBH4

## Slim Square D Handle



Stainless Steel  
Length: 190mm  
Drilling: 160mm  
Code: AHSSDH1

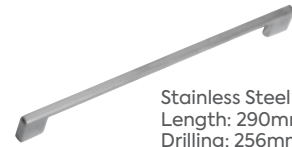

Stainless Steel  
Length: 290mm  
Drilling: 256mm  
Code: AHSSDH2

## Slim D Handle



Chrome  
Length: 120mm  
Drilling: 96mm  
Code: AHSDH1



Chrome  
Length: 220mm  
Drilling: 192mm  
Code: AHSDH2

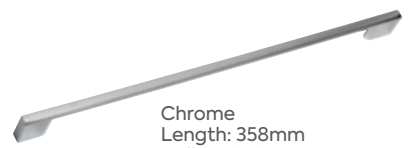

Chrome  
Length: 358mm  
Drilling: 320mm  
Code: AHSDH3

## Chunky Bow Handle



Stainless Steel  
Length: 182mm  
Drilling: 160mm  
Code: AHCBH1

## Contemporary D Handle



Brushed Nickel  
Length: 134mm  
Drilling: 128mm  
Code: AHAND6



Brushed Nickel  
Length: 166mm  
Drilling: 160mm  
Code: AHAND5

## Camden Bar Handle



Chrome  
Length: 168mm  
Drilling: 160mm  
Code: AH168CBC



Satin Chrome  
Length: 168mm  
Drilling: 160mm  
Code: AH168CBBN



### Barrington Pull Handle



Polished Nickel  
Length: 180mm  
Drilling: 160mm  
Code: AHGBAP160PN



Matt Black  
Length: 180mm  
Drilling: 160mm  
Code: AHGBAP160MBL



Bronze  
Length: 180mm  
Drilling: 160mm  
Code: AHGBAP160BRO



Brushed Satin Brass  
Length: 180mm  
Drilling: 160mm  
Code: AHGBAP160BSB

### Barrington Pull Handle and Backplate



Polished Nickel  
Length: 190mm  
Drilling: 160mm  
Code: AHGBAPGU01BP160PN



Matt Black  
Length: 190mm  
Drilling: 160mm  
Code: AHGBAPGU01BP160MBL



Bronze  
Length: 190mm  
Drilling: 160mm  
Code: AHGBAPGU01BP160BRO



Brushed Satin Brass  
Length: 190mm  
Drilling: 160mm  
Code: AHGBAPGU01BP160BSB

### Barrington Knob



Polished Nickel  
Diameter: 32mm  
Code: AHGBAK032PN



Matt Black  
Diameter: 32mm  
Code: AHGBAK032MBL



Bronze  
Diameter: 32mm  
Code: AHGBAK032BRO



Brushed Satin Brass  
Diameter: 32mm  
Code: AHGBAK032BSB

### Barrington Knob and Backplate



Polished Nickel  
Length: 100mm  
Code: AHGBAKBP32100PN



Matt Black  
Length: 100mm  
Code: AHGBAKBP32100MBL



Bronze  
Length: 100mm  
Code: AHGBAKBP32100BRO

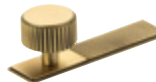

Brushed Satin Brass  
Length: 100mm  
Code: AHGBAKBP32100BSB

### Barrington Cup Handle



Polished Nickel  
Length: 105mm  
Drilling: 64mm  
Code: AHGBAC064PN



Matt Black  
Length: 105mm  
Drilling: 64mm  
Code: AHGBAC064MBL



Bronze  
Length: 105mm  
Drilling: 64mm  
Code: AHGBAC064BRO



Brushed Satin Brass  
Length: 105mm  
Drilling: 64mm  
Code: AHGBAC064BSB

### Barrington Eclipse Pull Handle Ribbed



Polished Nickel  
Length: 80mm  
Drilling: 64mm  
Code: AHGBETP064PN



Bronze  
Length: 80mm  
Drilling: 64mm  
Code: AHGBETP064BRO



Brushed Satin Brass  
Length: 80mm  
Drilling: 64mm  
Code: AHGBETP064BSB



### Lincoln Profile Handle



Brushed Nickel  
Length: 200mm  
Drilling: 128mm  
Code: AHGLIP128BN



Matt Black  
Length: 200mm  
Drilling: 128mm  
Code: AHGLIP128MBL



Brushed Nickel  
Length: 250mm  
Drilling: 192mm  
Code: AHGLIP192BN



Matt Black  
Length: 250mm  
Drilling: 192mm  
Code: AHGLIP192MBL



Brushed Nickel  
Length: 800mm  
Drilling: 768mm  
Code: AHGLIP786BN



Matt Black  
Length: 800mm  
Drilling: 768mm  
Code: AHGLIP768MBL

### Hampton Cup Handle



Polished Nickel  
Length: 122mm  
Drilling: 96mm  
Code: AHGHAC096PN



Dull Nickel  
Length: 122mm  
Drilling: 96mm  
Code: AHGHAC096DN



Matt Black  
Length: 122mm  
Drilling: 96mm  
Code: AHGHAC096MBL



Bronze  
Length: 122mm  
Drilling: 96mm  
Code: AHGHAC096BRO



Brushed Satin Brass  
Length: 122mm  
Drilling: 96mm  
Code: AHGHAC096BSB

### Hampton Cup Handle



Polished Nickel  
Length: 195mm  
Drilling: 160mm  
Code: AHGHAC160PN



Dull Nickel  
Length: 195mm  
Drilling: 160mm  
Code: AHGHAC160DN



Matt Black  
Length: 195mm  
Drilling: 160mm  
Code: AHGHAC160MBL



Bronze  
Length: 195mm  
Drilling: 160mm  
Code: AHGHAC160BRO



Brushed Satin Brass  
Length: 195mm  
Drilling: 160mm  
Code: AHGHAC160BSB

### Hampton Knob



Polished Nickel  
Diameter: 32mm  
Code: AHGHAK032PN



Dull Nickel  
Diameter: 32mm  
Code: AHGHAK032DN



Matt Black  
Diameter: 32mm  
Code: AHGHAK032MBL



Bronze  
Diameter: 32mm  
Code: AHGHAK032BRO



Brushed Satin Brass  
Diameter: 32mm  
Code: AHGHAK032BSB

### Ivo Knob



Polished Nickel  
Diameter: 45mm  
Code: AHGIVK045PN



Bronze  
Diameter: 45mm  
Code: AHGIVK045BRO



Brushed Satin Brass  
Diameter: 45mm  
Code: AHGIVK045BSB



### Kellas Bar Handle

 Brushed Anodised  
Length: 168mm  
Drilling: 160mm  
Code: AHGKEB160BA

 Matt Black  
Length: 168mm  
Drilling: 160mm  
Code: AHGKEB160MBL

 Satin Brass  
Length: 168mm  
Drilling: 160mm  
Code: AHGKEB160SB

### Kellas T Bar Knob

 Brushed Anodised  
Length: 60mm  
Code: AHGKEK060BA

 Matt Black  
Length: 60mm  
Code: AHGKEK060MBL

 Satin Brass  
Length: 60mm  
Code: AHGKEK060SB

### Belgravia Pull Handle

 Satin Brass Lacquered  
Length: 242mm  
Drilling: 160mm  
Code: AHGBELP160SBL

### Belgravia T Bar Knob

 Satin Brass Lacquered  
Length: 82mm  
Code: AHGBELK082SBL

### Belgravia Knob

 Satin Brass Lacquered  
Diameter: 35mm  
Code: AHGBELK038SBL

### Pembrey T Bar Knob

 Polished Nickel  
Length: 82mm  
Code: AHGPEK082PN

 Matt Black  
Length: 82mm  
Code: AHGPEK082MBL

 Bronze  
Length: 82mm  
Code: AHGPEK082BRO

### Pembrey Bar Handle

 Polished Nickel  
Length: 210mm  
Drilling: 128mm  
Code: AHGPEB128PN

 Matt Black  
Length: 210mm  
Drilling: 128mm  
Code: AHGPEB128MBL

 Bronze  
Length: 210mm  
Drilling: 128mm  
Code: AHGPEB128BRO

### Trafalgar Knob

 Polished Nickel  
Diameter: 38mm  
Code: AHGTRK038PN

 Antique Pewter  
Diameter: 38mm  
Code: AHGTRK038AP

 Bronze  
Diameter: 38mm  
Code: AHGTRK038BRO

### Trafalgar Cup Handle

 Polished Nickel  
Length: 102mm  
Drilling: 64mm  
Code: AHGTRC064PN

 Antique Pewter  
Length: 102mm  
Drilling: 64mm  
Code: AHGTRC064AP

 Bronze  
Length: 102mm  
Drilling: 64mm  
Code: AHGTRC064BRO

### Trafalgar Bow Handle

 Polished Nickel  
Length: 142mm  
Drilling: 96mm  
Code: AHGTRB096PN

 Antique Pewter  
Length: 142mm  
Drilling: 96mm  
Code: AHGTRB096AP

 Bronze  
Length: 142mm  
Drilling: 96mm  
Code: AHGTRB096BRO

# Marketing Support

## ByBA.co.uk

BA has always been committed to investing in marketing activity to support our dealer network and at a time when many are reducing sales and marketing activities, BA have continued to invest in quality materials and campaigns to build business for its trade dealers.

Our mobile, tablet and desktop friendly website showcases all our products and services as well as driving customers to the dealer network. The site has been designed to not only be informative to the end customer but to be an essential and useful sales tool for all BA Dealers.

You can use the website to show your customers over 1000 style and colour combinations across all the BA ranges giving you and your client some fabulous ideas on colours, styles and layouts. Overall this represents one of the most wide reaching promotional programmes in our market place today, and in conjunction with our social media campaigns, trade press advertising, great brochures and point of sale material, exhibition activity and a first class customer care programme it is the envy of our competition.

The BA advertising campaigns are always fresh, innovative and very important to the continued growth of BA and more importantly its dealers. Our advertising represents not only the whole support ethos of BA but a real reason to buy into the BA Brands.



byba.co.uk

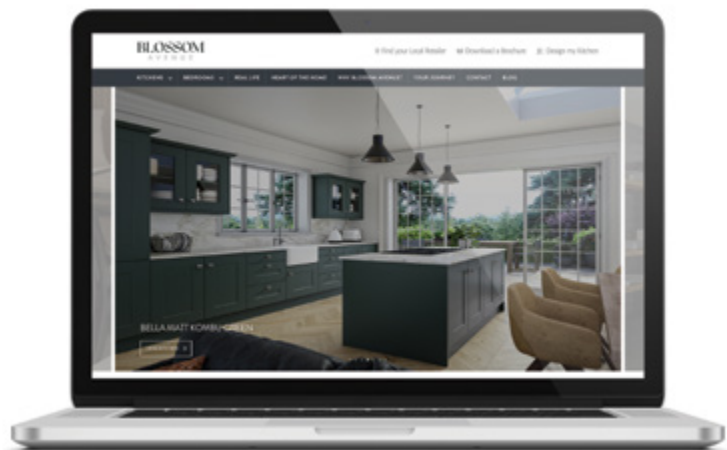

blossomavenue.co.uk

## BA Dealer Network

The Dealer Locator drives Sales Leads Direct to You!

The dealer locator allows consumers to not only find you as a local dealer, but interact with you even before they visit.



---

## Order a sample service

We've all been there. Your client is ready to make a final decision and you can't locate your BA sample!

We have the solution, order your customer a sample and leave your precious samples where you need them most, in your showroom. Simply go online and order a sample via MyBA.

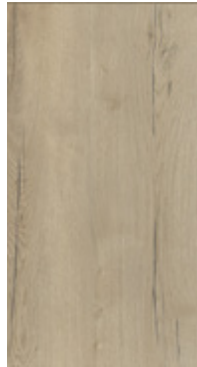

---

## Digital Material and Imagery

To order promotional items, send orders to: [cookorders@byba.co.uk](mailto:cookorders@byba.co.uk) or via MyBA

*Delivery charges will apply*

Please contact [marketing@byba.co.uk](mailto:marketing@byba.co.uk) for Blossom Avenue digital brochures.



### Kitchen Brochure

Our consumer facing brochure showcasing our stocked and made to measure door ranges and accessories across all our colours and styles.

Code: PROKITBRO

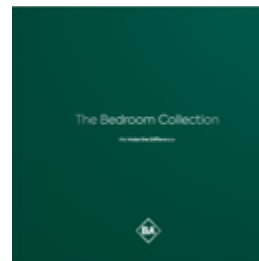

### The Bedroom Collection Brochures

Our consumer facing brochure showcasing our Bedroom Collection offer. Maximum of 25 brochures supplied to active customers. FOC.

Code: PROCOMBEDBRO

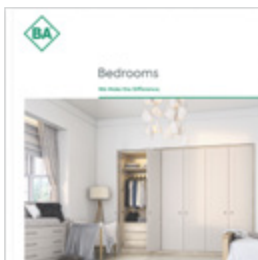

### Bedroom Brochure

Our consumer facing brochure showcasing made to measure bedroom door ranges and accessories. Supplied in packs of 10. Maximum of 50 brochures supplied to active customers. FOC.

Code: PROBEBBRO



### Product Information Guide

A comprehensive guide to our product offering. Ask your ASM for a copy of our digital Retail Price List. FOC.

Code: PROPIG

# Promotional Material

ByBA.co.uk



## BA Photo Library

Kitchen and bedroom images in high resolution jpeg format for your own promotional material.

Please send your request to [marketing@byba.co.uk](mailto:marketing@byba.co.uk) or log on to MyBA to download from our Image Library under the 'Marketing Assets' section.

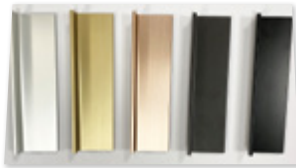

## Gola Rail Sample Set

200mm length of Gola rail in all 5 available colours.  
Code: **PROGRSS**

## Door Ranges Poster

1m x 460mm  
At a glance poster showing BA door ranges. Ideal for showroom display.

Code: **PRODRP**



## Door Display Unit Branded with Blossom Avenue

2088mm H x 440mm W x 610mm D.  
28 door positions to fit 570 x 396 BA doors.  
(Doors not included)

Code: **PPRODDU1**



## Door Display Unit\*

2088mm H x 440mm W x 610mm D.  
28 door positions to fit 570 x 396 BA doors.  
(Doors not included)

Code: **PPRODDUG2**

## CLICBOX

### ClicBox Sample Cabinet

Panels are a mix of the 5 ClicBox colour options.  
370H x 300W x 285D

Code: **PROCBSC**



## SHOWROOM DISPLAYS:

For Display Rates contact your Area Sales Manager, see page 4.



To order promotional items send orders to: [cookorders@byba.co.uk](mailto:cookorders@byba.co.uk) or via MyBA. (Delivery charges will apply).

## Stocked Door Sample Material



### Stocked Sample Door Pack

**Sample Door Pack:**  
33 x 570 x 396 doors.  
Contains all doors in the range (except Thornbury and Hadley).  
Sample Pack Code: **PROPRONTOSP**  
Individual Doors: specify name & colour.



### Thornbury/Hadley Sample Doors

**Individual Doors:**  
specify name & colour.



### Jayline/Firbeck Swatch

150mm x 100mm vinyl samples of all Jayline/Firbeck colours in a binder.  
Code: **PROFJCS**



### Thornbury/Hadley Swatch

150mm x 100mm matt painted samples of all Thornbury/Hadley colours in a binder.  
Code: **PROTCSS**

## Zurfiz Sample Material

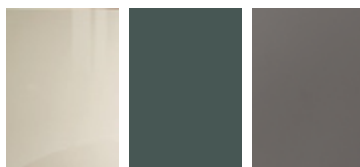

### Zurfiz Sample Door Pack

**Sample Door Pack:**  
26 x 396 x 280 doors with a mix of matching or glass effect edges.  
Sample Pack Code: **PROZURFIZSP**  
Individual Doors: specify name & colour.



### Sample Door Bag

Heavy duty nylon bag which will hold 10 x 396 x 280 doors. Suitable for Valore and Zurfiz samples.  
Code: **PROZSDB**



### Zurfiz Swatch

150mm x 100mm samples of all Zurfiz colours in a binder.  
Code: **PROZCS**

## Bella Sample Material



### Bella Sample Door Pack

**Sample Door Pack:**  
38 x 570 x 396mm doors. Contains most styles and colours in the Bella Range.  
Sample Pack Code: **PROBELLASP**  
Individual Doors: specify name & colour.



### Bella Colour Swatch Folder

150mm x 150mm vinyl samples of all Bella colours in a ring binder. Code: **PROBCS**

## Valore Sample Material



### Valore Sample Door Pack

**Sample Door Pack:**  
16 x 396 x 280 edged on all 4 sides.  
Sample Pack Code: **PROVALORESP**  
Individual Doors: specify name & colour.



### Valore Swatch

150mm x 100mm laminate samples of all Valore colours in a binder. Code: **PROVCS**



### Sample Door Bag

Heavy duty nylon bag which will hold 5 x 570 x 396 doors. Suitable for Stocked and Bella door samples.  
Code: **PRO570SDB**

# Book A Tour

Doncaster | Cookstown | Rotherham

Bespoke, made-to-measure doors with no minimum order quantity and an unrivalled range of accessories.

Established over thirty years with a skill set and a pedigree going back over 100 years, put BA top of your contact list for quotations and specifications whatever your requirements.

Why not book one of our tours, it offers a fascinating glimpse behind the scenes at the BA Doncaster factory, giving you a genuine insight into the work and love that goes into producing each one of our products.



Doncaster



Cookstown



Rotherham

# Door Care

## Care and Maintenance

As with all timber based items our products should not be stored or installed in a newly plastered or damp environment.

To avoid damage by excessive heat please follow these simple guidelines:

- When installing doors adjacent to ovens always ensure that doors are shielded by using heat deflector strips
- Never use any appliance which generates high levels of heat or concentrated steam (such as a toaster, kettle or pressure cooker) directly under or adjacent to a door or panel.

### Gloss and matt colours

- After removing the protective film please allow the surface to cure for seven days before cleaning or wiping.
- Polishing High Gloss finishes will leave minor scratches and polish marks, this is normal with this type of finish.

### To clean door surfaces:

- Wipe using a soft cloth with a mild, non abrasive, dishwashing detergent diluted in warm water. The mix should be 1% detergent to 99% warm water (not wet).
- Dry off with a soft dry cloth.
- You should never use any vinegar based detergents, solvents, abrasive detergents, white spirit, Brillo pads or furniture polish.



### Gloss Door After Care Kit

Code: APOLISH

## We have a number of Door After Care Kits available:

### Gloss Door After Care Kit

- Kit includes a 235ml aerosol of VuPlex polish, micro anti scratch polishing cloth and full instructions.
- The door care kit is suitable for use with all gloss door finishes.
- VuPlex special formula cleans using safe ingredients that won't damage the surface.
- The anti static properties limit the amount of dust particles attracted to the surface that can lead to scratching.
- Accelerates the hardening process on high gloss finishes after film removal which increases protection instantly. Apply directly after removal of film.
- Leaves a coating of polymer that acts as an invisible barrier stopping small scratches & sun light fade.
- Polishes the surface leaving a high lustre streak free finish.



### Supermatt Door After Care Kit

Code: ASMCK

### Supermatt Door After Care Kit

- Kit includes a 250ml spray bottle of matt laminate cleaner, microfibre cloth, magic eraser x 2 and full instructions.
- The door care kit is suitable for use with Supermatt door finishes.
- Special formula cleans using safe ingredients that won't damage the surface.
- Leaves fingerprint and streak free with a fantastic low sheen finish.

### Painted Door After Care Kit

- Kit includes softwax, applicator, scotchbrite pad and touch up pen.
- Ideal for repairing scratches and scuff marks on the Thornbury and Hadley doors.
- Available in 6 colours, specify when ordering.



### Painted Door After Care Kit, specify name and colour

# Help and Support

---

Technical Resources and Marketing Assets are available to download from MyBA.

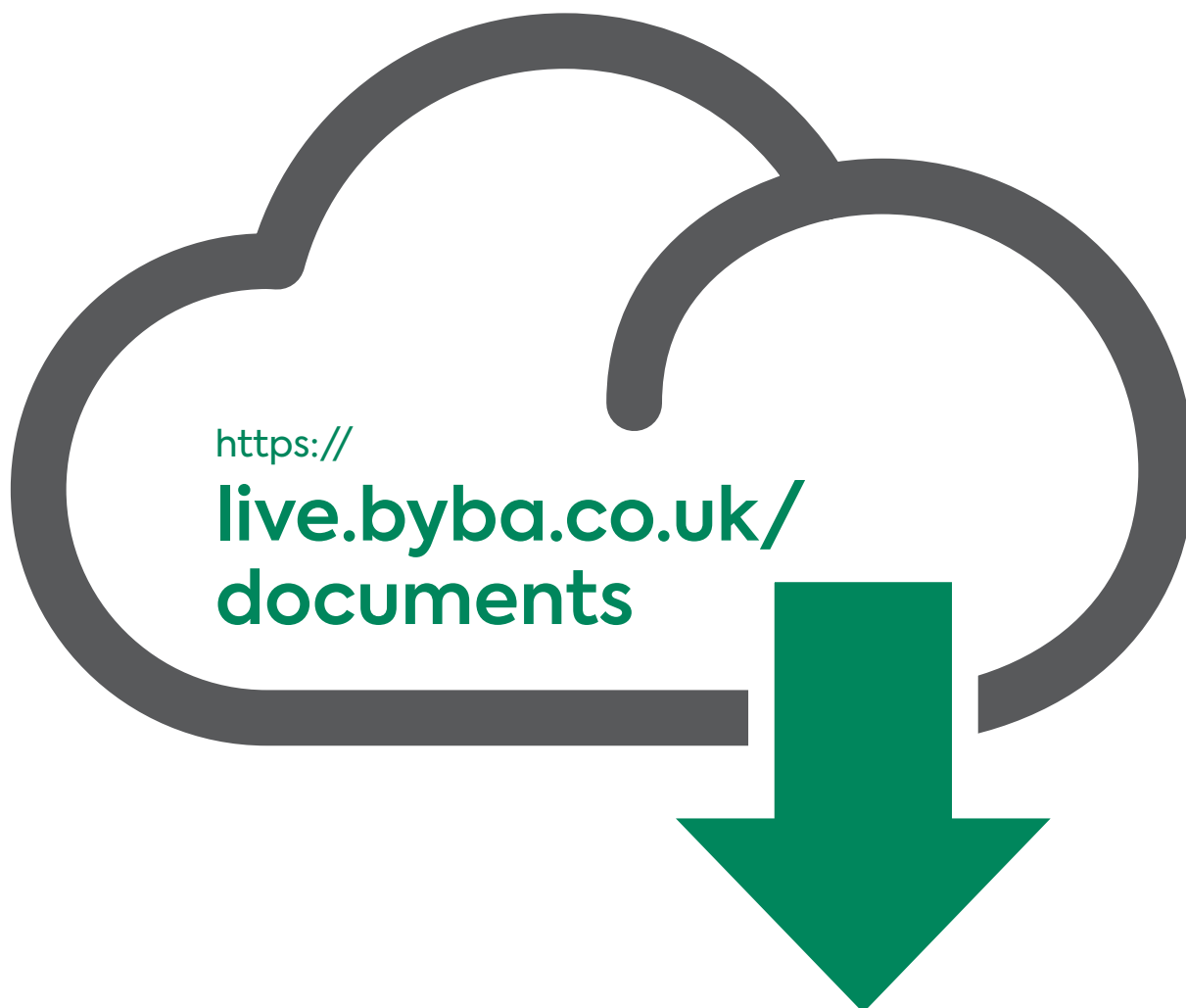

Simply log on to MyBA and go to Help and Support to access:

- Marketing Assets
- Lead Times
- Delivery Info
- Technical Resources

# Conditions of Sale

## Terms & Conditions

This contract is made under the following terms and conditions. Please read these terms and conditions carefully as they affect your rights and liabilities under the law.

### 1 Contract Parties

- 1.1 BA Components is a trading division of BA Kitchen Components Ltd, a company registered in Northern Ireland under company number NI 029035, and whose registered office is Derryloran Industrial Estate, Cookstown, Co Tyrone, BT80 9LU.
- 1.2 The contract is between you (The Buyer) and BA Components (The Seller).

### 2 Your Status

By placing an order with BA Components, you warrant that:

- 2.1 you are legally capable of entering into binding contracts.
- 2.2 you are at least 18 years old; and
- 2.3 you have read and understood the guidance on our site (MyBA) and Product Information Guide (PIG) as to how orders should be made

### 3 Contract Formation

- 3.1 Your order constitutes an offer to us to buy Product(s) subject to these terms and conditions. The contract between us (Contract) will only be formed when we receive your order in writing. If ordering via MyBA, this will be deemed when you have received email notification that your order has been successfully received.
- 3.2 We reserve the right to reject an order for whatever reason it deems necessary.

### 4 Your Rights

- 4.1 You may cancel or amend an order FOC provided the goods have not entered production or in the case of stocked products, before they have been picked.
- 4.2 Any cancellation or amendment to an order containing stocked products which has been released for picking but not yet despatched will be subject to an administration fee 25% of the order value (minimum charge £25).

### 5 Delivery

- 5.1 We will use all reasonable endeavours to fulfil your order between or on the delivery date set out in the Order Confirmation unless there are exceptional circumstances and the delivery is affected by factors beyond our control.
- 5.2 Delivery dates are not guaranteed, and we will let you know if we become aware of an unexpected delay and will arrange a new delivery date with you.
- 5.3 If you fail to take delivery of an order on the specified delivery date, we will notify you that the products are ready for delivery, or we cannot deliver due to your failure to provide relevant instructions, documents, licenses or authorisations then, except where this failure is caused by our failure to comply with these terms and conditions or by an event beyond your control:
  - 5.3.1 we will store the Goods until delivery takes place and may charge you a reasonable sum currently £15 a day to cover expenses and insurance;
  - 5.3.2 we shall have no liability to you for late delivery; and
  - 5.3.3 Where delivery has taken place as agreed but we were unable to leave the Products we will have the right to any additional delivery charges if you require a further delivery later.
- 5.4 If you have not taken delivery of the Products within two weeks of our notifying you that they are ready, we may, after giving you reasonable prior notice in writing, resell or otherwise dispose of part or all of the Products and, after deducting reasonable storage and selling costs, or the price if they are bespoke Products and cannot be resold, pay you for any excess over the price of the Products or charge you for any shortfall below their original price.
- 5.5 If we are not able to deliver the whole of the order at one time due to operational reasons or shortage of stock, we will deliver the order in instalments. We will not charge you extra delivery costs for this. If you ask us to deliver the order in instalments, we may charge you extra delivery costs. Each instalment shall constitute a separate Contract. If we are late delivering an instalment or one instalment is faulty, that will not entitle you to cancel any other instalment.
- 5.6 Upon delivery of the Products you are responsible for inspecting the Products and reporting to us within 5 working days of any alleged defect, fault, shortage, or error before the Products are used or fitted. We shall have no liability for any claim in respect of an alleged defect, fault or error which would be apparent on inspection before use or fitting.
- 5.7 Transit damage claims will be honoured if the POD has been signed DAMAGED and reported to us within 5 working days from the date of delivery.

### 6 Risk and Title

- 6.1 Ownership of the Products will only pass to you when delivery has been completed.
- 6.2 Unless otherwise agreed in writing by us, customer shall have no right or license to use the BA Components trademarks.

### 7 Price and Payment

- 7.1 Product prices and delivery charges exclude VAT.
- 7.2 Product prices and delivery charges are liable to change at any time, but changes will not be made to orders where you have received an order acknowledgment.
- 7.3 The BA Components Retail offering contains a vast number of products and may contain some pricing errors. If the pricing error is obvious and unmistakable and could have been reasonably recognised by you as an error, we do not have to provide the Products to you at the incorrect (lower) price.
- 7.4 Payment options will be available to you at the time of order. Orders will only be accepted if one of options has been successfully completed.

### 8 Claims and Refunds

- 8.1 As detailed in 5.6 and 5.7, all claims must be notified to us in writing within 5 working days of receiving the delivery
- 8.2 All claims must quote the original sales order number, detail reasons for the product rejection, include digital photographic evidence of the damage where possible and state if a replacement item is required. Items that have been drilled, altered, have scratches, dents or corner damage due to lack of care will not be accepted. The Seller will only replace like for like products and shall in no way be responsible for any additional consequential costs or losses
- 8.3 The Seller will endeavour to despatch a replacement order within 4 working days or 2 working days in the case of a stocked product from the date the claim has been received
- 8.4 All replacement orders will be initially charged for. As part of the investigation into the claim a representative of the Seller may request to view the damaged product at the Sellers address. Any credit due for damaged product will be processed within 30 working days of receiving the claim
- 8.5 Unless otherwise agreed, all delivery costs for product returned to BA Components will be borne by the Buyer. It is advisable when returning any item(s) to us you cover with the appropriate additional insurance to cover the total item(s) value. If this additional cover isn't applied to item(s)

# Conditions of Sale

- that are returned to us we cannot be held responsible for any damage that may occur in transit by the carrier.
- 8.6 If you return a stocked Product to us because you have cancelled the Contract between us within a seven-day cooling-off period, we will process the refund due to you as soon as possible and, in any case, within 7 days of the day on which you returned the Products to us. In this case, we will refund the price of the Product in full, and any applicable delivery charges subject to the returned product being fit for resale. However, you will be responsible for the cost of returning the Products to us. Products returned after the cooling off period will be subject to a restocking charge of 25% of the order value (minimum charge £25).
- 8.7 We will usually refund any money received from you using the same method originally used by you to pay for your purchase.

## 9 Warranty and Recommended Good Practice for Specific Products

- 9.1 We warrant to you that any Product purchased from us, on delivery, conform in all material respects with its description, be of satisfactory quality, and be reasonably fit for all the purposes for which Products of that kind are commonly supplied and will adhere to FIRA Gold/Gold Level H Certification, FIRA FS 6250 2018 Environmental Performance (Table 4b = Max bow of 1mm over 600mm span if measured when the doors are acclimatised for a period of 96 hrs to a temperature of 18-25c) and BS EN 17214:2019.
- 9.2 The following products carry the stated guarantee period for defects in materials only from the date of invoice:
- 9.2.1 All MDF/MFC based products - 6yrs
- 9.2.2 Solid Timber based products - 1yr
- 9.2.3 Hettich hinges and drawers - 20yrs
- 9.2.4 Handles - 1yr
- 9.3 This warranty does not apply to any defect in the Products arising from:
- 9.3.1 fair wear and tear;
- 9.3.2 wilful damage, accident, or negligence by you or any third party.
- 9.3.3 if you use the Products in a way that we do not recommend.
- 9.3.4 your failure to follow our instructions.
- 9.3.5 any alteration or repair you carry out without our prior written approval; or
- 9.3.6 Any incorrect instructions or plans submitted by you on our site to enable us to provide the Products.
- 9.4 We reserve the right to investigate all warranty claims to determine if the claim is due to a manufacturing defect resulting in product performance failure or to incorrect fabrication, installation, or misuse. We are only

- responsible for manufacturing defects and will at its choice repair, replace or refund the cost of the product.
- 9.5 We give no warranty and shall have no liability if product manufacture or sale infringes on any intellectual property right ("IPR") under which we are not licensed. We reserve the right without liability to the Customer other than refund of any portion of the price paid to discontinue manufacture, sale, or deliveries of any product which in our opinion would infringe any IPR.
- 9.6 The following best practice is recommended for certain products:
- 9.6.1 All Timber based products should only be cleaned with a damp cloth applying minimum amount of moisture or alternative approved cleaning polishes. Do not use any cleaning products containing solvents
- 9.6.2 After removing the protective film from High Gloss Products, please note that the finish has a 7 day curing process then the surface should only be polished with Vuplex polish or similar product using a micro anti-scratch polishing cloth
- 9.6.3 Products supplied which are placed near heat sources such as ovens, radiators, grills, boiling Kettles, toasters etc are not covered by the guarantee unless protected by suitable heat strips with a suitable gap left for heat escape
- 9.6.4 Products situated below a sink, or covering a dishwasher/washing machine are not covered, unless the damage is anything other than excessive steam or water contact.
- 9.7 In the unlikely event that the original colour in some of the MDF/MFC based products is discontinued, the nearest possible alternative will be offered at our discretion.
- 9.8 The Seller accepts no liability for and consequential losses, costs or refitting charges

## 10 Our Liability

- 10.1 Subject to clause 10.3, if we fail to comply with these terms and conditions, we shall only be liable to you for the purchase price of the Products and, subject to clause 10.2, any losses that you suffer as a result of our failure to comply (whether arising in contract, tort (including negligence), breach of statutory duty or otherwise) which are a foreseeable consequence of such failure.
- 10.2 Subject to clause 10.3, we will not be liable for losses that result from our failure to comply with these terms and conditions that fall into the following categories even if such losses result from our deliberate breach:
- 10.2.1 loss of income or revenue.
- 10.2.2 loss of business.
- 10.2.3 loss of profits.
- 10.2.4 loss of anticipated savings.
- 10.2.5 loss of data; or
- 10.2.6 Waste of management or office

- time. However, this clause 10.2 will not prevent claims for loss of or damage to your physical property that are foreseeable or any other claims for direct loss that are not excluded by categories 10.2.1 to 10.2.6 inclusive of this clause 10.2.
- 10.3 Nothing in this agreement excludes or limits our liability for:
- 10.3.1 death or personal injury caused by our negligence.
- 10.3.2 fraud or fraudulent misrepresentation.
- 10.3.3 any breach of the obligations implied by section 12 of the Sale of Goods Act 1979 or section 2 of the Supply of Goods and Services Act 1982.
- 10.3.4 defective Products under the Consumer Protection Act 1987; or
- 10.3.5 Any other matter for which it would be illegal for us to exclude or attempt to exclude our liability.

## 11 Written Communications

Applicable laws require that some of the information or communications we send to you should be in writing. When using MyBA, you accept that communication with us will be mainly electronic. We will contact you by e-mail or provide you with information by posting notices on our website. For contractual purposes, you agree to this electronic means of communication and you acknowledge that all contracts, notices, information and other communications that we provide to you electronically comply with any legal requirement that such communications be in writing. This condition does not affect your statutory rights.

## 12 Cancellation By Us and Product Changes

- 12.1 We reserve the right to cancel the Contract between us if:
- 12.1.1 we or our suppliers have insufficient stock to deliver the Products you have ordered, or such Products have been discontinued.
- 12.1.2 we do not deliver to your area; or
- 12.1.3 one or more of the Products you ordered was listed at an incorrect price due to a typographical error or an error in the pricing information received by us from our supplier.
- 12.2 If we do cancel your Contract, we will notify you by e-mail and will re-credit you account by any sum deducted by us from your credit card as soon as possible but in any event within 30 days of your order. We will not be liable to pay any additional compensation for disappointment suffered.
- 12.3 When we or our suppliers have insufficient stock to deliver the Products you have ordered or such Products have been discontinued we reserve the right to provide substitute Products to you of the equivalent quality and price at our discretion instead of exercising our right to cancel in condition 12.1 above. If you, as a consumer exercise your right to

---

cancel as set out above the cost of returning such substitute Products to us will be met by us.

- 12.4 We reserve the right, and without incurring any liability to the buyer to:
- 12.4.1 Alter the specifications for any Product;
- 12.4.2 Discontinue the manufacture of any Product;
- 12.4.3 Discontinue the development of any new product, whether or not such product has been announced publicly;
- 12.4.4 Commence the manufacture and sale of new products having features which make any Product wholly or partially obsolete, whether or not Distributor is granted any distribution rights in respect of such new products; and/or
- 12.4.5 Withdraw any Product from marketing at any time. Notwithstanding the above, the Company shall use reasonable efforts to provide Distributor with prompt written notice of any such decisions.

### 13 Transfer of Rights and Obligations

---

- 13.1 The contract between you and us is binding on you and us and on our respective successors and assignees.
- 13.2 You may not transfer, assign, charge or otherwise dispose of a Contract, or any of your rights or obligations arising under it, without our prior written consent.
- 13.3 We may transfer, assign, charge, sub-contract or otherwise dispose of a Contract, or any of our rights or obligations arising under it, at any time during the term of the Contract.

### 14 Events Outside Our Control

---

- 14.1 We will not be liable or responsible for any failure to perform, or delay in performance of, any of our obligations under a Contract that is caused by events outside our reasonable control (Force Majeure Event).
- 14.2 A Force Majeure Event includes any act, event, non-happening, omission, or accident beyond our reasonable control and includes (without limitation) the following:
- 14.2.1 strikes, lockouts or other industrial action.
- 14.2.2 civil commotion, riot, invasion, terrorist attack or threat of terrorist attack, war (whether declared or not) or threat or preparation for war.
- 14.2.3 fire, explosion, storm, flood, earthquake, subsidence, epidemic or other natural disaster.
- 14.2.4 impossibility of the use of railways, shipping, aircraft, motor transport or other means of public or private transport.
- 14.2.5 impossibility of the use of public or private telecommunications networks.
- 14.2.6 the acts, decrees, legislation,

regulations, or restrictions of any government; and

- 14.2.7 pandemic or epidemic.
- 14.3 Our performance under any Contract is deemed to be suspended for the period that the Force Majeure Event continues, and we will have an extension of time for performance for the duration of that period. We will use our reasonable endeavours to bring the Force Majeure Event to a close or to find a solution by which our obligations under the Contract may be performed despite the Force Majeure Event.

### 15 Waiver

---

- 15.1 If we fail, at any time during the term of a Contract, to insist upon strict performance of any of your obligations under the Contract or any of these terms and conditions, or if we fail to exercise any of the rights or remedies to which we are entitled under the Contract, this will not constitute a waiver of such rights or remedies and will not relieve you from compliance with such obligations.
- 15.2 A waiver by us of any default will not constitute a waiver of any subsequent default.
- 15.3 No waiver by us of any of these terms and conditions will be effective unless it is expressly stated to be a waiver and is communicated to you in writing in accordance with clause above.

### 16 Severability

---

If any court or competent authority decides that any of the provisions of these terms and Conditions or any provisions of a Contract are invalid, unlawful or unenforceable to any extent, the term will, to that extent only, be severed from the remaining terms, which will continue to be valid to the fullest extent permitted by law.

### 17 Entire Agreement

---

- 17.1 These terms and conditions and any document expressly referred to in them constitute the whole agreement between us and supersede all previous discussions, correspondence, negotiations, previous arrangement, understanding or agreement between us relating to the subject matter of any Contract.
- 17.2 We each acknowledge that, in entering into a Contract, neither of us relies on, or will have any remedies in respect of, any representation or warranty (whether made innocently or negligently) that is not set out in these terms and conditions or the documents referred to in them. Any changes to the specification of the Products or variations to the contract or these terms and conditions that you agree with our authorised employees

or agents will only be binding if recorded in writing and signed by a director of the company.

- 17.3 Each of us agrees that our only liability in respect of those representations and warranties that are set out in this agreement (whether made innocently or negligently) will be for breach of contract.
- 17.4 Nothing in this clause limits or excludes any liability for fraud.

### 18 Variations of These Terms and Conditions

---

- 18.1 We have the right to revise and amend the products, price lists or these terms and conditions from time to time to reflect changes in market conditions affecting our business, changes in technology, changes in payment methods, changes in relevant laws and regulatory requirements and changes in our system's capabilities.
- 18.2 You will be subject to the policies and terms and conditions in force at the time that you order Products from us, unless any change to those policies or these terms and conditions is required to be made by law or governmental authority (in which case it will apply to orders previously placed by you), or if we notify you of the change to those policies or these terms and conditions before we send you the Order Confirmation (in which case we have the right to assume that you have accepted the change to the terms and conditions).

### 19 Law and Jurisdiction

---

This contract is subject to the Laws of Northern Ireland and the buyer will submit to the exclusive jurisdiction of the Northern Ireland Courts.

### 20 Third Party Right

---

A person who is not party to these terms and conditions or a Contract shall not have any rights under or in connection with them under the Contracts (Rights of Third Parties) Act 1999.

### 21 Email and SMS Communications

---

By providing your contact details to BA Components, you will be indicating to us your consent for us to contact you by email and SMS to let you know about your order delivery or offers/promotions, which may be of interest to you, unless you indicate an objection to receiving such messages. You can also unsubscribe from marketing email communications from within our emails.

**BA Cookstown**  
Derryloran Industrial Estate  
Cookstown  
Co. Tyrone  
BT80 9LU

T +44 (0)28 8676 4600  
F +44 (0)28 8676 4404

**BA Doncaster**  
Sandall Stones Road  
Kirk Sandall, Doncaster  
South Yorkshire  
DN3 1QR

T +44 (0)1302 890555  
F +44 (0)1302 886724

**BA Rotherham**  
Unit 2, Barbados Way  
Hellaby Industrial Estate  
Rotherham, South Yorkshire  
S66 8RX

T +44 (0)1709 545277

For more information  
visit [ByBA.co.uk](http://ByBA.co.uk)

[sales@byba.co.uk](mailto:sales@byba.co.uk)

**ByBA.co.uk**  
**We Make the Difference.**

